

IOWA ROTOCAST PLASTICS

2021 PRODUCT CATALOG



INDEX

New Products | 2

RotoTough | 12

Racks & Stackers | 28

Breezers | 36

Fabrication | 38

Grab and Go | 52

Sanitizers | 60

Grizzly | 66



Custom Capabilities page 74

HISTORY OF IRP



- 1985** Super Cooler (the predecessor to IRP) begins production of the original keg cooler in a building constructed on the founder/CEO's home property.
- 1986** Company name changes and becomes incorporated as Iowa Rotocast Plastics, Inc. and moves to new 4,000 sq ft location in Decorah, IA.
- 1994** The Arctic is born and sold to Coca-Cola. Kolor Graphics is created as an in-house printer to fulfill the growing demands.
- 1998** IRP moves to current location in Decorah, IA and constructs 20,000 sq ft production facility.
- 2006** Several additions totaling over 100,000 additional sq ft – fabrication line developed to satisfy increasing demand for fabricated carts and kiosks. A third rotational molding oven is added to the second IRP location - a large capacity oven.
- 2009** IRP adds a 60,000 sq ft second physical location.
- 2012** Grizzly Coolers is launched as the re-branded image of roto-molded coolers manufactured by IRP taking a more B2C-focused position in the market.
- 2016** IRP adds a powder coating line to the second IRP location. A fourth rotational molding oven is added to the main IRP location - a high volume oven.
- 2017** IRP is awarded the US Bank Stadium bid in Minneapolis, MN, launching a series of stadium and venue books of business to follow.
- 2019** IRP introduces an ACM line of fabricated carts for more cost effective construction. IRP is also awarded Wrigley Field and Allianz Field stadium bids.
- 2020** In response to Covid-19, IRP developed a line of hand sanitizers to promote health and safety. Nashville Soccer and Cincinnati Soccer stadiums both award fabrication bids to IRP.
- TODAY** Launched re-branded e-commerce website and constructed new staging area in our fabrication facility. Company restructures to allow for the next generation of family members to take on executive leadership roles.



Iowa Rotocast Plastics, incorporated in 1986, is an established manufacturer and supplier of merchandising equipment for the food and beverage industry. IRP caters to beverage brands and food-service and hospitality groups, as well as working directly with stadiums, venues, and arenas to fulfill year-over-year needs.

The IRP family of brands is divided into three main product categories: RotoTough™ products that include ice-down merchandising solutions and case stackers; wire racks and electronic refrigeration; and IRP's fabricated food & beverage equipment built for on/off premise. IRP equipment meets or exceeds required industry regulations and is NSF and UL approved.

NEW

BACKPACK COOLER

FEATURES

- Lightweight design - 2.8 lbs empty
- Custom branding capability
- Water resistant integrated pocket
- Carabiner style clips
- Keeps beverages cold 24 hours

DIMENSIONS

- 14" L x 6" W x 18 3/4" H

CAPACITY

- 15 - 12oz cans
- 12 - 12oz slim cans
- 10 - 16oz cans
- 6 - 24/25oz cans
- 10 - 20oz bottles
- 2.8 gallons



INTERIOR



TOP POCKET

LARGE ZIPPER HANDLE

BRANDING AREA

ADJUSTABLE STRAPS

CARABINER CLIPS



BREW BOX

FEATURES

- Durable rotomolded construction
- 2" of polyurethane foam insulation
- 304 Stainless steel draft components
- Lid and base graphics
- Includes coupler assemblies
- Faucets, knobs, and shanks included

DIMENSIONS

- 17.25" H x 30.375" L x 17.375" D

CAPACITY

- 60 Quarts
- 2 - 10 ft 3/8" Coils
- 2 - 20 ft 1/4" Choke

AVAILABLE IN 2 COLORS



GREY



WHITE

NEW

COMING SOON
2022

ICEFALL

FEATURES

- Removable lid with integrated vent
- Integrated reservoir tank
- Graphic slots for custom branding
- Interchangeable graphic with snap channels
- RotoTough™ Construction
- Optional chip rack

DIMENSIONS

- 25.5" W x 16.07" D x 57.5" H

CAPACITY

- 24 - 16oz. cans
- 24 - 20oz. bottles
- 24 - 24/25oz. cans



WATER DRAIN





ROTO-MOLDED PUB TABLE

FEATURES

- Cost effective Rotomolded base & top
- Table top graphics
- Optional bucket insert on table top (14.25" Dia)
- Available with branded graphics

DIMENSIONS

- 35" Dia x 41.875" H



BUCKET INSERT

NEW

ROTOTOUGH

RACKS

BREEZERS

FABRICATION

SANITIZERS

GRIZZLY

CUSTOM

NEW

PRECISION SERIES

ACM CASINO CART

FEATURES

- Frame-less ACM construction
- Stainless steel countertop & push handle
- Lockable door either end of cart
- Speed rail shown server right (removable)
- Bumper and skirt around perimeter
- 2 Rigid & 2 swivel locking 4" casters
- 11 gal consumable ice bin with stainless lid

DIMENSIONS

- 24 W" x 40.25 L" x 37.5" H

CAPACITY

- 56 - 12 oz. slim cans
- 50 - 12 oz. cans
- 36 - 16 oz. cans
- 26 - 20 oz. bottles
- 21 - 24/25 oz. cans

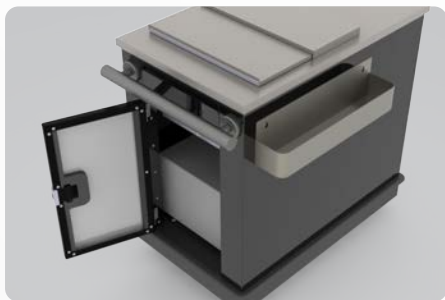

**LOCKING DOORS ON
BOTH ENDS**



MOBILE TRIKE

NEW

FEATURES

- Umbrella mount
- Locking storage underneath
- Metal trike frame
- Draft or package options
- Interchangeable graphics



UMBRELLA MOUNT



PACKAGE

FEATURES

- Dual sided stainless steel lid
- 100 qt drop in

DIMENSIONS

- 88" L x 26" W x 45.5" H

CAPACITY

- 147 - 12 oz slim cans
- 120 - 12 oz cans
- 90 - 16 oz cans
- 70 - 24/25 oz cans
- 70 - 20 oz bottles



DRAFT

FEATURES

- Double spigot draft tower
- Iced-down coil bin w/lid
- 14" Drip tray
- 11 Gallon reservoir tank

DIMENSIONS

- 88" L x 26" W x 56.5" H

CAPACITY

- 2 - 1/6 kegs



NEW

ROTOTOUGH

RACKS

BREEZERS

FABRICATION

SANITIZERS

GRIZZLY

CUSTOM

NEW

CLEARVIEW DRINKS & MERCH

Setup your very own stop and shop store anywhere with our new portable Clearview Grab & Go! These portable units can be setup anywhere and have limitless possibilities for use. Portability, locking security doors and durable construction make the Clearview Grab & Go the perfect option for any venue.



16' ENCLOSURE

12' ENCLOSURE

FEATURES

- Header graphic
- Direct print ACM
- Breezer UR-2 with sliding doors and custom graphics
- Compact POS marine board-24
- Black PVC header sign
- Locking tambour roll up door

DIMENSIONS

- 161.125" W x 157.125" D x 122.562" H

16' ENCLOSURE

FEATURES

- Header graphic
- Direct print ACM
- Breezer UR-2 with sliding doors and custom graphics
- Compact POS marine board-24
- Black PVC header sign
- Locking tambour roll up door

DIMENSIONS

- 213.5" W x 157.125" D x 122.562" H

24' ENCLOSURE

FEATURES

- Header graphic
- Direct print ACM
- Breezer UR-2 with sliding doors and custom graphics
- Compact POS marine board-24
- Black PVC header sign
- Locking tambour roll up door

DIMENSIONS

- 318.25" W x 157.125" D x 122.562" H



24' ENCLOSURE

CUSTOMIZABLE MERCHANDISING

IRP's Grab N' Go products paired with the Acrylic Enclosure allows you to create the perfect layout for your merchandising needs.



INDOOR USE RECOMMENDED
OPEN AIR ROOF



12' ENCLOSURE

ROTOTOUGH

The IRP RotoTough product line encompasses double-walled rotationally molded plastic products with interior foam insulation. This product line is intended to chill, preserve, and promote your beverage through the use of ice. Hallmark features of this line include extreme durability and longevity...many units in the field are still in use 10-15 years after purchase. If you need a no-fuss portable workhorse with optimal ROI, the RotoTough line is the ideal choice.



DURABILITY



**MADE IN
THE USA**



**IN-HOUSE BRANDING
& GRAPHICS**

COUNTERTOP SERIES

CHILLER

FEATURES

- Large exterior area to place graphics
- Light weight makes it easy to move to and from storage
- Small countertop footprint for virtually unlimited placement options



SPECIFICATIONS

DIMENSIONS

- 36" W x 18" D x 8" H

CAPACITY

- 74 - 12oz. cans
- 74 - 16oz. cans
- 60 - 20oz. bottles
- 55 - 24/25oz. cans
- 48 - quarts

COUNTERTOP SERIES

ICER ELITE

FEATURES

- Great for back-bars or sampling
- Graphic channels for easy graphic swap
- 360° branding
- Lightweight, uses less plastic



SPECIFICATIONS

DIMENSIONS

- 17.25" Dia. x 9.75" H

CAPACITY

- 28 - 12oz. cans
- 21 - 16oz. cans
- 19 - 20oz. bottles
- 18 - 24/25oz. cans
- 22 - quarts

SPECIFICATIONS

DIMENSIONS

- 16.75" W x 17.5" D x 12.25" H

CAPACITY

- 24 - 12oz. cans
- 20 - 16oz. cans
- 20 - 20oz. bottles
- 16 - 24/25oz. cans
- 24 - quarts

COUNTERTOP SERIES

MAXIMIZER

FEATURES

- Large exterior area to place graphics
- Light weight makes it easy to move to and from storage
- Small countertop footprint for virtually unlimited placement options



SPECIFICATIONS

DIMENSIONS

- 11" W x 11" D x 7.5" H

CAPACITY

- 9 - 12oz. cans
- 9 - 16oz. cans
- 6 - 20oz. bottles
- 6 - 24/25oz. cans
- 6 - quarts

COUNTERTOP SERIES

MINI-MAXIMIZER

FEATURES

- Multiple exterior areas to place graphics
- Light weight makes it easy to move to and from storage
- Small countertop footprint for virtually unlimited placement options



ICE CADDY 100

FEATURES

- Interchangeable graphics
- RotoTough™ construction & handles for easy moving
- RotoTough™ removable lid for easy loading



*Custom graphics invalidate NSF certification.



SPECIFICATIONS

DIMENSIONS

- 22.25" W x 30.25" D x 28.75" H

CAPACITY

- 135 - 12oz. cans
- 100 - 16oz. cans
- 64 - 20oz. bottles
- 64 - 24/25oz. cans
- 84 - quarts
- 100 lbs. of ice



ICE CADDY

FEATURES

- Interchangeable graphics
- RotoTough™ construction & handles for easy moving
- RotoTough™ removable lid for easy loading

SPECIFICATIONS

DIMENSIONS

- 36.25" W x 27" D x 35" H

CAPACITY

- 320 - 12oz. cans
- 240 - 16oz. cans
- 177 - 20oz. bottles
- 177 - 24/25oz. cans
- 232 - quarts



ICE HAWK

FEATURES

- Crystal clear lid for visibility and complete access
- Highly durable rotomolded construction with foam insulation provides superior ice retention
- Improved, easily interchangeable graphics
- Premium casters for easy mobility

DIMENSIONS

- 21.25" Dia. x 36" H

CAPACITY

- 106 - 12oz. cans
- 82 - 16oz. cans
- 60 - 20oz. bottles
- 52 - 24/25oz. cans
- 72 - quarts



MERCH III

FEATURES

- Interchangeable graphics
- Heavy duty wheel system for easy mobility
- Redesigned flat lid

DIMENSIONS

- 16.5" Dia. x 37.25" H

CAPACITY

- 56 - 12oz. cans
- 42 - 16oz. cans
- 30 - 20oz. bottles
- 26 - 24/25oz. cans
- 44 - quarts



ICEBERG

FEATURES

- Interchangeable graphics
- Unique design fits flat against aisle ends
- Heavy duty wheel system for easy mobility
- 5 quart internal reservoir

DIMENSIONS

- 21.5" W x 16.5" D x 33.75" H

CAPACITY

- 88 - 12oz. cans
- 66 - 16oz. cans
- 46 - 20oz. bottles
- 42 - 24/25oz. cans
- 64 - quarts



MERCH I

FEATURES

- Interchangeable graphics
- Available in ice-less innovation: includes full set of ice packs that keeps product cold where ice is not an option

DIMENSIONS

- 21.25" Dia. x 36" H

CAPACITY

- 106 - 12oz. cans
- 82 - 16oz. cans
- 60 - 20oz. bottles
- 52 - 24/25oz. cans
- 72 - quarts



REAR GRAPHIC CHANNELS



SPECIFICATIONS

DIMENSIONS

- 50.5" W x 24" D x 38" H

CAPACITY

- 448 - 12oz. cans
- 336 - 16oz. cans
- 196 - 20oz. bottles
- 196 - 24/25oz. cans
- 288 - quarts

ARCTIC

FEATURES

- Interchangeable graphics
- Mold-in divider for easy brand separation
- Heavy duty wheels for easy mobility
- Mold-in handles and umbrella holder
- Locking lid to keep product safe



SPECIFICATIONS

DIMENSIONS

- 60.5" W x 31.5" D x 37" H

CAPACITY

- 720 - 12oz. cans
- 560 - 16oz. cans
- 384 - 20oz. bottles
- 324 - 24/25oz. cans
- 440 - quarts



SUPER ARCTIC

FEATURES

- Interchangeable graphics
- Mold-in divider for easy brand separation
- Heavy duty wheels for easy mobility
- Mold-in handles and umbrella holder
- Optional Pole Topper w/ LED light kit
- Locking lid to keep product safe



POLE TOPPER



TEXAS ICER

FEATURES

- Interchangeable graphics
- Large pack-out with shelf below
- Heavy-duty drain assembly with 16 quart capacity

DIMENSIONS

- 48" W x 24" D x 36" H

CAPACITY

- 128 - 12oz. cans
- 105 - 20oz. bottles
- 122 - 16oz. cans
- 105 - 24/25oz. cans
- 120 - quarts

TEXAS ICER MINI

FEATURES

- Interchangeable graphics
- Dividers for brand separation

DIMENSIONS

- 23.5" W x 23.5" D x 32.5" H

CAPACITY

- 98 - 12oz. cans
- 36 - 20oz. bottles
- 63 - 16oz. cans
- 36 - 24/25oz. cans
- 64 - quarts

TEXAS ICER JR.

FEATURES

- Interchangeable graphics
- Designed with convenient shelf below
- Dividers for brand separation

DIMENSIONS

- 36" W x 24" D x 34.25" H

CAPACITY

- 96 - 12oz. cans
- 74 - 20oz. bottles
- 80 - quarts
- 74 - 16oz. cans
- 74 - 24/25oz. cans



PUSH CART

FEATURES

- Interchangeable graphics
- Optional cash register and umbrella for all-in-one mobile selling
- Built in handles for easy mobility
- Optional pole topper with graphics and LED light kit

DIMENSIONS

- 53.5" W x 30" D x 40" H

CAPACITY

- 352 - 12oz. cans
- 261 - 16oz. cans
- 141 - 20oz. bottles
- 153 - 24/25oz. cans
- 228 - quarts



POLE TOPPER



TEXAS TANKER

FEATURES

- Durable Rotomolded construction
- Rotomolded divider for brand separation
- Heavy duty casters
- Interchangeable graphics

DIMENSIONS

- 44.5" W x 27.25" D x 30.5" H

CAPACITY

- 436 - 12oz. cans
- 296 - 16oz. cans
- 224 - 20oz. bottles
- 168 - 24/25oz. cans
- 256 - quarts



FROST BOX

FEATURES

- Interchangeable graphics
- Durable rotomolded construction
- Dividers to keep brands separate
- Available with skirting for a high-end look

DIMENSIONS

- 36" W x 24" D x 34.5" H

CAPACITY

- 144 - 12oz. cans
- 105 - 16oz. cans
- 77 - 20oz. bottles
- 77 - 24/25oz. cans
- 96 - quarts



PANTRY COOLER 2 WIDE

FEATURES

- Interchangeable graphics
- Large pack-out with shelf below
- Heavy-duty drain assembly with 16 quart capacity

DIMENSIONS

- 30" W x 20" D x 51" H

CAPACITY

- 120 - 12oz. cans
- 55 - 20oz. bottles
- 76 - quarts
- 84 - 16oz. cans
- 55 - 24/25oz. cans



PANTRY COOLER 3 WIDE

FEATURES

- Interchangeable graphics
- Designed with convenient shelf below
- Dividers for brand separation
- Rear wire sign holder

DIMENSIONS

- 36.812" W x 20.625" D x 51" H

CAPACITY

- 108 - 12oz. cans
- 60 - 20oz. bottles
- 76 - quarts
- 72 - 16oz. cans
- 60 - 24/25oz. cans



AVALANCHE

FEATURES

- Interchangeable graphics
- Modular design for larger pack-out with smaller footprint
- Slide-in dividers for brand separation
- Cross-merchandising options

DIMENSIONS

- 30" W x 16" D x 35" H

CAPACITY

- 160 - 12oz. cans
- 72 - 20oz. bottles
- 112 - quarts
- 112 - 16oz. cans
- 72 - 24/25oz. cans



SUPER COOLER

FEATURES

- RotoTough™ construction for extra durability
- Durable, insulated keg cooler
- Lid saves ice while allowing access to your tap

DIMENSIONS

- 24.5" Dia x 27" H

CAPACITY

- 100 quarts
- 1 keg

ICE ISLAND

FEATURES

- Portable reservoir tank
- Optional header card and price strips
- Optional bridge rack available
- Full panel interchangeable graphics
- Shorter core with huge pack-out saves ice and money

DIMENSIONS

- 80" W x 35" D x 35" H

CAPACITY

- 360 - 12oz. cans
- 216 - 16oz. cans
- 216 - 20oz. bottles
- 216 - 24/25oz. cans
- 320 - quarts



PORTABLE RESERVOIR TANK



HAWKERS

FEATURES

- New and improved padded harness with harness attachment featuring quick detach system
- Rotomolded construction features molded-in handles with nestable design for easy storage and is 100% recyclable
- Ergonomic curved back and light weight - the lightest hawkler on the market!
- Large Recessed graphic area to amplify your brand

MULTI HAWKER ELITE

DIMENSIONS

- 23.125" W x 17.875" D x 7.375" H

CAPACITY

- 32 - 12oz. cans
- 32 - 16oz. cans
- 24 - 20oz. bottles
- 24 - 24/25oz. cans

HAWKER ELITE

DIMENSIONS

- 22.625" W x 14.75" D x 10" H

CAPACITY

- 64 - 12oz. cans
- 45 - 16oz. cans
- 26 - 20oz. bottles
- 25 - 24/25oz. cans

NEW

ROTOTOUGH

RACKS

BREEZERS

FABRICATION

GRAB N GO

SANITIZERS

GRIZZLY

CUSTOM

LARGE GRAPHICS

100% RECYCLABLE

IMPROVED HARNESS

LIGHTWEIGHT

NEW

SIDELINE CART

The Sideline Cart Series is IRP's sporting event solution. Available options include a drink cart serving dual purpose with it's ample storage, and a taping cart to facilitate sideline treatment.



LOCKING STORAGE



DRAWER DOWELS

DEEP DRAWERS

6" LOCKING CASTERS

BRANDING LOCATIONS





SIDELINE CART NEW

DIMENSIONS

48" W x 32" D x 36" H

FEATURES

- RotoTough™ construction
- Three deep drawers
- Rear storage with locking door
- Custom colors and graphics available
- Rotomolded hard top
- Water runoff trough with bottle storage

NEW

ROTOTOUGH

RACKS

BREEZERS

FABRICATION

GRAB N GO

SANITIZERS

GRIZZLY

CUSTOM

RACKS & STACKERS

Optimized Merchandise Displays. IRP Product Displays are available in durable plastic or metal, depending on your needs and footprint. The IRP Wire Racks are an attractive solution to displaying bulk product quantities without sacrificing excessive floor space.



CUSTOM
DESIGNS



POWDER
COATING



IN-HOUSE BRANDING
& GRAPHICS



SIGNATURE SERIES

INTERCHANGEABLE RACK

FEATURES

- Interchangeable graphics
- Four shelves with shelf strip areas
- Angled shelves for ease of access

DIMENSIONS

- 23" W x 16.5" D x 52" H

CAPACITY

- 32 - 6 pack bottles
- 24 - 12 pack cans
- 12 - 18 pack cans
- 8 - 30 pack cans

SIGNATURE SERIES

MINI RACK

FEATURES

- Interchangeable graphics
- Four shelves with shelf strip areas
- Heavy duty casters for easy mobility
- Angled shelves for ease of access

DIMENSIONS

- 20" W x 11" D x 62" H

CAPACITY

- 16 - 6 pack bottles
- 12 - 12 pack cans
- 4 - 18 pack cans
- 4 - 30 pack cans

INTERCHANGEABLE RACK

FEATURES

- Interchangeable graphics
- Four shelves with shelf strip areas

DIMENSIONS

- 24.5" W x 17" D x 46.5" H

CAPACITY

- 32 - 6 pack bottles
- 24 - 12 pack cans
- 12 - 18 pack cans
- 8 - 30 pack cans



MINI RACK

FEATURES

- Interchangeable graphics
- Four shelves with shelf strip areas
- Sheet metal shelves available for liquor bottles

DIMENSIONS

- 20" W x 11.5" D x 62.5" H

CAPACITY

- 16 - 6 pack bottles
- 12 - 12 pack cans
- 4 - 18 pa cans
- 4 - 30 pack cans



SIGNATURE SERIES

WEEKENDER SMALL

FEATURES

- Interchangeable graphics
- Heavy duty system for large pack-out display
- Stainless steel construction
- Four casters for easy mobility

DIMENSIONS

- 32" W x 17" D x 61.5" H

CAPACITY

- 24 - 12 pack cans
- 12 - 24 packs



SIGNATURE SERIES

WEEKENDER LARGE

FEATURES

- Interchangeable graphics
- Heavy duty system for large pack-out display
- Stainless steel construction
- Four casters for easy mobility

DIMENSIONS

- 32" W x 34.5" D x 61.5" H

CAPACITY

- 72 - 12 pack cans
- 36 - 24 packs



CASE-STACKER I

DIMENSIONS

- 16.5" W x 11.5" D x 4.5" H

CAPACITY

- 12oz. 12 pk glass bottles – 6 pks, 2 per layer
- 12oz. fridge pk – 8 packs, 2 per layer
- 12oz. 12 pk – 10 pks, 2 per layer
- 12oz. 24 pk – 5 pks, 1 per layer
- 12oz. 30 pk – 6 pks, 2 per layer
- 16oz. 18 pk – 5 pks, 1 per layer
- Aluminum bottles 9 pk – 6 pks, 2 per layer

CASE-STACKER II

DIMENSIONS

- 20.5" W x 16.5" D x 4.5" H

CAPACITY

- 12oz. 12 pk glass bottles – 12 pks, 4 per layer
- 12oz. fridge pk – 24 pks, 4 per layer
- 12oz. 12 pk – 20 pks, 4 per layer
- 12oz. 24 pk – 10 pks, 2 per layer
- 12oz. 30 pk – 6 pks, 2 per layer
- 16oz. 18 pk – 8 pks, 2 per layer
- Aluminum bottles 9 pk – 12 pks, 4 per layer

CASE-STACKER III

DIMENSIONS

- 32" W x 16" D x 4.5" H

CAPACITY

- 12oz. 12 pk glass bottles – 18 pks, 6 per layer
- 12oz. fridge pk – 30 pks, 6 per layer
- 12oz. 12 pk – 30 pks, 6 per layer
- 12oz. 24 pk – 15 pks, 3 per layer
- 12oz. 30 pk – 12 pks, 4 per layer
- 16oz. 18 pk – 16 pks, 4 per layer
- Aluminum bottles 9 pk – 24 pks, 8 per layer



HANGING 6-PACK RACK

FEATURES

- Use in displays or on cooler doors
- Six shelves of product display
- Adjustable width bracket

DIMENSIONS

- 24.5" W x 7.5" D x 65.5" H

CAPACITY

- 18 - 6 packs



SIDE LOADER

FEATURES

- Multiple price strip areas
- Door hook support aided by multiple suction cups

12 CAN

DIMENSIONS

- 5.5" W x 4" D x 51.5" H

CAPACITY

- 12 - 12oz cans
- 12 - 16oz cans
- 12 - 24/25oz cans

8 CAN

DIMENSIONS

- 5.5" W x 4" D x 35.5" H

CAPACITY

- 8 - 12oz cans
- 8 - 16oz cans
- 8 - 24/25oz cans

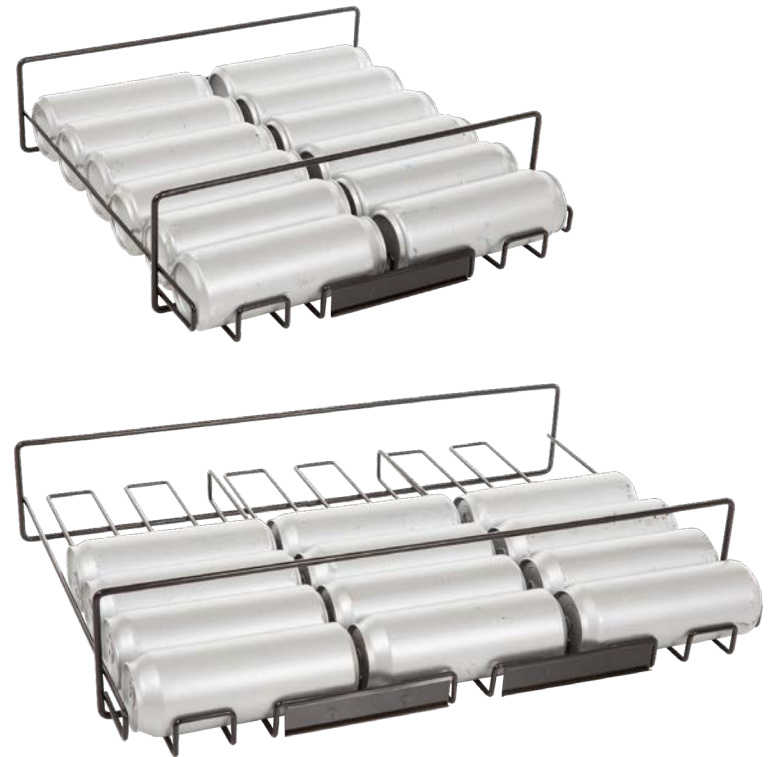

UNDER-SHELF RACK

FEATURES

- Price strip areas
- Sloped for products to roll toward front

2 WIDE

DIMENSIONS

- 20.25" W x 21.5" D x 4.5" H

CAPACITY

- 14 - 24oz cans

3 WIDE

DIMENSIONS

- 25.25" W x 21.75" D x 4.5" H

CAPACITY

- 21 - 24oz cans



LARGE GRAPHIC AREA



PRICE STRIP AREAS

10.5" OVERHEAD GAP

CASTERS

5 SHELF RACK **NEW**

FEATURES

- Interchangeable graphics
- Five shelves with price strip areas
- Product accessible from both sides
- Small Footprint – Big Pack out

DIMENSIONS

- 16" W x 16" D x 74.5" H
- Shelf: 9.25" x 14.5"

CAPACITY

- 75 - 12oz cans
- 75 - 16oz cans
- 30 - 4 pack slim cans
- 15 - 8 pack slim cans
- 10 - 6 pack bottles



DUAL SIDE PRODUCT ACCESS

NEW
ROTOTOUGH
RACKS
BREEZERS
FABRICATION
GRAB N GO
SANITIZERS
GRIZZLY
CUSTOM

MINI BOTTLE RACK **NEW**

SPECIFICATIONS

DIMENSIONS

- 7.75" W x 6.375" D x 21" H

CAPACITY

- 80 - 57ml bottles

FEATURES

- Clear acrylic mini bottle display for 360 degree product viewing
- Compact size
- Clear shelf dividers
- Removable front panel for optional security



ADJUSTABLE RACK **NEW**

SPECIFICATIONS

DIMENSIONS

- 18.25" W x 11.5" D x 48.375" H

CAPACITY

- 16 - 6 pack bottles (4 per shelf)
- 12 - 12 pack cans (3 per shelf)
- 24 - 4 pack slim cans (6 per shelf)
- 72 - 20oz bottles (18 per shelf)



FEATURES

- 4 independently adjustable shelves
- Interchangeable graphics
- Sheet metal shelves available for liquor bottles

ROLLING RACK XL **NEW**

FEATURES

- Interchangeable graphics
- 2 shelves for stacking product
- Steel construction
- Four casters for easy mobility



LOW RIDER **NEW**

FEATURES

- Interchangeable graphics
- Heavy duty casters for easy mobility
- Available with or without casters

SPECIFICATIONS

DIMENSIONS

- 46.625" W x 10.125" D x 20.875" H

CAPACITY

- 36 - 12 pack cans
- 18 - 24 pack cans

SPECIFICATIONS

DIMENSIONS

- 46.5" W x 10.5" D x 10.5" H

CAPACITY

- 30 - 12 pack cans
- 15 - 24 pack cans

BREEZERS



BREEZER CT

FEATURES

- Durable steel construction
- Eco-friendly R134a refrigerant
- Exterior light switch and thermostat control
- LED illuminated header
- Low energy double pane tempered glass

DIMENSIONS

- 19.125" W x 21.375" D x 36.25" H

CAPACITY

- 84 - 12oz. cans
- 64 - 16oz. cans
- 34 - 20oz. bottles
- 64 - 24/25oz. cans



BREEZER II

FEATURES

- Recessed molded-in handles
- Casters for easy mobility
- Divider for brand separation
- Adjustable thermostat
- Fan assisted rapid cooling

DIMENSIONS

- 17.5" Dia. x 37.875" H

CAPACITY

- 72 - 12oz. cans
- 62 - 16oz. cans
- 54 - 20oz. bottles
- 28 - 24/25oz. cans



BREEZER III

FEATURES

- Interior illumination
- Spring loaded product chutes to push product to the top
- Adjustable thermostat
- Fan assisted rapid cooling
- Minimum quantities may apply

DIMENSIONS

- 33" W x 25.75" D x 33.5" H

CAPACITY

- 112 - 12oz. cans
- 112 - 16oz. cans
- 112 - 24/25oz. cans



UR BREEZERS

FEATURES

- Casters
- Plastic front grill
- Cyclopentane insulation
- Heavy duty wire shelves
- Electronic fan motors
- LED perimeter lighting
- Locking high efficiency glass door
- Electronic temperature controller
- Durable steel construction
- Eco-friendly R134a refrigerant
- Available with sliding or hinged doors

BREEZER UR-1

DIMENSIONS

- 29.5" W x 27.375" D x 78.75" H

CAPACITY

- 315 - 12oz. cans
- 315 - 16oz. cans
- 240 - 20oz. bottles
- 240 - 24/25oz. cans

BREEZER UR-2

DIMENSIONS

- 54.125" W x 29.625" D x 78.375" H

CAPACITY

- 630 - 12oz. cans
- 630 - 16oz. cans
- 480 - 20oz. bottles
- 480 - 24/25oz. cans

NEW

FABRICATED CARTS

IRP has significant experience in the design and fabrication of carts and kiosks in professional or collegiate sports venues, stadiums, arenas and resorts. IRP carts and kiosks can be created to your exact specifications, no cart is too big or small. All our carts can be designed with a combination of food & beverage serving options, or as mobile retail or P.O.S. stations.



DURABILITY



MADE IN
THE USA



IN-HOUSE BRANDING
& GRAPHICS



Safety version on page 63



ELITE SERIES

FEATURES

- New illuminated canopy with down lighting
- Full panel interchangeable graphics
- Steel frame for optimal strength
- 6" heavy duty casters
- Stainless steel uprights

4 KEG DRAFT

DIMENSIONS

84" W x 25" D x 108" H

CAPACITY

- Up to 4 half keg barrels

PACKAGE

DIMENSIONS

62" W x 32" D x 91" H

CAPACITY

- 344 - quarts

- 612 - 12oz. cans
- 432 - 16oz. cans
- 292 - 20oz. bottles
- 280 - 24/25oz. cans

NEW

ROTOTOUGH

RACKS

BREEZERS

FABRICATION

GRAB N GO

SANITIZERS

GRIZZLY

CUSTOM



IPC-280

FEATURES

- RotoTough™ product shelf
- RotoTough™ divider for brand separation
- RotoTough™ sliding locking lid
- Available with canopy
- Interchangeable graphic system

DIMENSIONS

- 53.5" W x 26" D x 96" H

CAPACITY

- 448 - 12oz. cans
- 336 - 16oz. cans
- 196 - 20oz. bottles
- 196 - 24/25oz. cans
- 280 - quarts



CYK

FEATURES

- RotoTough™ illuminated canopy
- RotoTough™ serving shelf
- RotoTough™ divider for brand separation
- RotoTough™ handles for easy moving
- Interchangeable graphic system

DIMENSIONS

- 60.5" W x 31" D x 96" H

CAPACITY

- 420 - 12oz. cans
- 296 - 16oz. cans
- 204 - 20oz. bottles
- 176 - 24/25oz. cans
- 240 - quarts



ICC-1

FEATURES

- Industry exclusive telescoping canopy
- Product shelf with plexi front to provide theft elimination and a cleaner serving environment.
- Interchangeable graphics system
- RotoTough™ construction & heavy duty wheels
- Molded-in divider for brand separation

DIMENSIONS

- 60" W x 30" D x 98" H

CAPACITY

- 598 - 12oz. cans
- 428 - 16oz. cans
- 284 - 20oz. bottles
- 240 - 24/25oz. cans
- 320 - quarts



PRECISION SERIES

ACM 10" BOX HEADER

FEATURES

- x2 - 32" monitors
- Interchangeable graphics
- Down lighting
- Stainless steel counter top
- Elevated theft guard doubles as a serving shelf

PACKAGE

DRAFT

DIMENSIONS

- 92"L x 32"D x 91"H

CAPACITY

- 456 - 12oz. cans
- 300 - 16oz. cans
- 180 - 20oz. bottles
- 180 - 24/25oz. cans
- 2 - 135 quart drop-ins

DIMENSIONS

- 96"L x 25"D x 95"H

CAPACITY

- 4 - half keg barrels

PRECISION ACM CARTS

IRP's new line of Precision ACM carts offers a durable top tier product with 4 week lead times and big savings for our customers. Available in many options to fill all your needs!



4 WEEKS LEAD TIME

NEW



PRECISION SERIES

ACM 6" BOX HEADER

FEATURES

- 32" monitor
- Interchangeable graphics
- Down lighting
- Stainless steel counter top
- Elevated theft guard
- Header custom text available

DRAFT

DIMENSIONS

96" L x 25" D x 96" H

CAPACITY

- 4 - half keg barrels

PACKAGE

DIMENSIONS

92" L x 32" D x 92" H

CAPACITY

- 456 - 12oz. cans
- 300 - 16oz. cans
- 180 - 20oz. bottles
- 180 - 24/25oz. cans
- 2 - 135 quart drop-ins



PRECISION SERIES

ACM SPOILER HEADER

FEATURES

- x2 - 32" monitors
- Interchangeable graphics
- Down lighting
- Stainless steel counter top
- Elevated theft guard doubles as a serving shelf

DRAFT

DIMENSIONS

96"L x 25"D x 96"H

CAPACITY

- 4 - half keg barrels

PACKAGE

DIMENSIONS

92"L x 32"D x 92"H

CAPACITY

- 456 - 12oz. cans
- 300 - 16oz. cans
- 180 - 20oz. bottles
- 180 - 24/25oz. cans
- 2 - 135 quart drop-ins

NEW



PRECISION SERIES

ACM K89 HEADER

FEATURES

- Interchangeable graphics
- Down lighting
- Stainless steel counter top
- Elevated theft guard doubles as a serving shelf

DRAFT

DIMENSIONS

96"L x 32"D x 95"H

CAPACITY

- 4 - half keg barrels

PACKAGE

DIMENSIONS

92"L x 32"D x 92"H

CAPACITY

- 456 - 12oz. cans
- 300 - 16oz. cans
- 180 - 20oz. bottles
- 180 - 24/25oz. cans
- 2 - 135 quart drop-ins



32" ACM P.O.S. CART

34.5" W x 33.375" D x 36.25" H



48" ACM P.O.S. CART

50.5" W x 33.375" D x 36.25" H



70" ACM P.O.S. CART

72.5" W x 33.375" D x 36.25" H



92" ACM P.O.S. CART

94.5" W x 33.375" D x 36.25" H

PRECISION SERIES

ACM P.O.S. CARTS

FEATURES

- Optional custom graphics
- Interchangeable graphic areas
- Lockable storage
- Stainless steel counter top
- Optional Point of sale access port

NEW

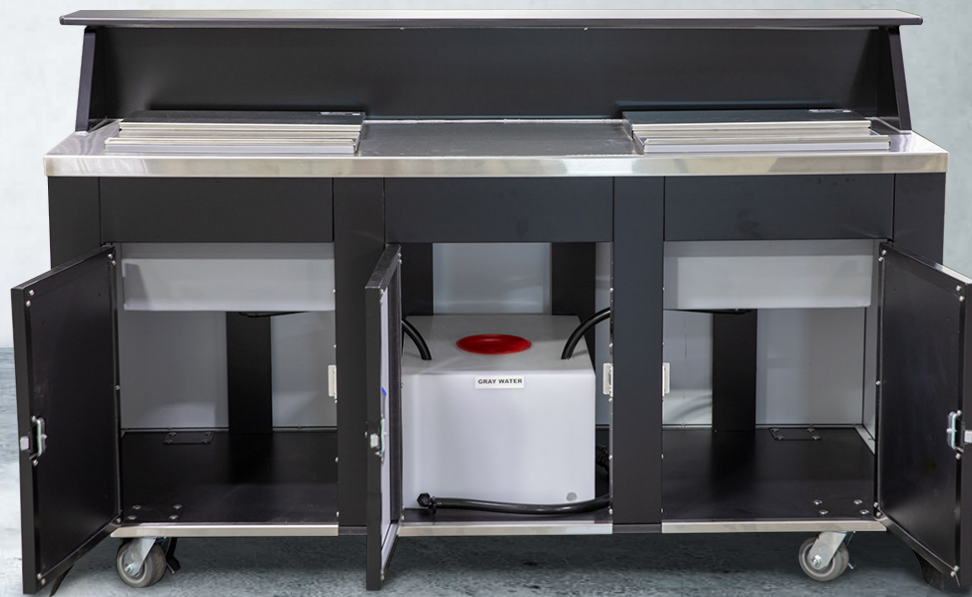

PRECISION SERIES

ACM BAR CART

DIMENSIONS

- 74"L x 30.5"D x 45.375"H

FEATURES

- 2 - 58qt Consumable ice bins w/ SS lids; NSF Approved
- 2 - 14" Speed Rails
- 1 - 15 gallon Water Reservoir tank
- 4" Casters
- Bumper & Skirting
- Available in Black or Brushed ACM; Branding available on front and sides

ELECTRIC

FEATURES

- 20A P.O.S. receptacle
- Under-counter LED Lights on both customer & server side





CHROME TOWEL DISPENSER

SOAP DISPENSER

HEATER ON/OFF SWITCH

PRECISION SERIES

ACM SINK CART

FEATURES

- 2.7 Gallon Electric Water Heater
- 5 Gallon Fresh Water Reservoir
- 8 Gallon Gray Water Reservoir
- Soap Dispenser
- 3 Gallon Trash Can
- Chrome Towel Dispenser
- Lockable Storage
- Available in Black or Brushed ACM; Branding available on front and sides

DIMENSIONS

- 33.5"L x 33.375"D x 42.375"H



TOUCHLESS OPTION



INTERIOR

NEW

ROTOTOUGH

RACKS

BREEZERS

FABRICATION

GRAB N GO

SANITIZERS

GRIZZLY

CUSTOM

NEW



PRECISION SERIES

48" CONDIMENT CART

FEATURES

- Server only condiment cart for prepackaged room temp condiments
- 4 4" Deep plastic third size food pans
- 8 4" Deep plastic sixth size food pans
- Lockable storage

DIMENSIONS

- 50.5"L x 33.375"D x 54.375"H



PRECISION SERIES

70" CONDIMENT CART

FEATURES

- Server only condiment cart for prepackaged room temp condiments
- 4 4" Deep plastic third size food pans
- 8 4" Deep plastic sixth size food pans
- Lockable storage
- Internal garbage receptacles

DIMENSIONS

- 34.5"L x 33.375"D x 54.375"H



PRECISION SERIES

32" CONDIMENT CART

FEATURES

- Server only condiment cart for prepackaged room temp condiments
- 2 4" Deep plastic third size food pans
- 8 4" Deep plastic sixth size food pans
- Lockable storage

DIMENSIONS

- 34.5"L x 33.375"D x 55"H



PRECISION SERIES

92" CONDIMENT CART

FEATURES

- Server only condiment cart for prepackaged room temp condiments
- 8 4" Deep plastic third size food pans
- 16 4" Deep plastic sixth size food pans
- Lockable storage

DIMENSIONS

- 94.5"L x 33.375"D x 54.375"H

UNIVERSAL SELLING STATION

3 PIECE DRAFT

If you can dream it, you can build it with the IRP Universal Ultimate Selling Station. Mix and match any option and create any size of selling station needed for your location, on or off premise.

Customizing your Universal System is a quick and easy way to get the most use from your chosen unit. Our large optional canopy provides excellent shade for vendors, as well as shelter from the elements.



COMBINATIONS

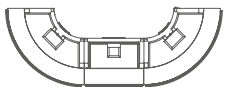

3 PIECE

10' 7.875" W x 3' 9.875" D x 7' 6.5" H

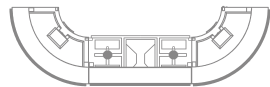

3 PIECE DRAFT

14' 7" W x 4' D x 7' 7" H

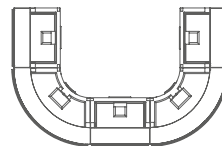

5 PIECE

10' 8" W x 6' 10" D x 7' 6.5" H

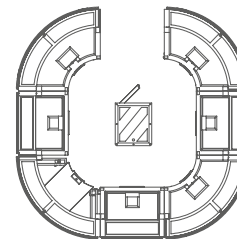

7 PIECE

10' 8" W x 10' 8" D x 7' 6.5" H

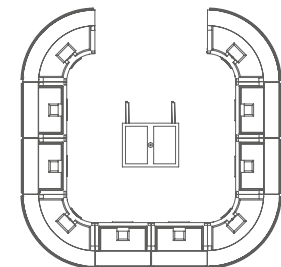

10 PIECE

13' 8" W x 13' 8" D x 7' 6.5" H



CURVE

FEATURES

- Interchangeable graphics
- RotoTough™ construction
- Optional external reservoir and locking lids

DIMENSIONS

- 66" W x 33" D x 91" H

CAPACITY

- 452 - 12oz. cans
- 374- 16oz. cans
- 240 - 20oz. bottles
- 212 - 24/25oz. cans
- 280 - quarts



STRAIGHT

FEATURES

- Interchangeable graphics
- RotoTough™ construction
- Optional external reservoir and locking lids

DIMENSIONS

- 36" W x 28" D x 91" H

CAPACITY

- 336 - 12oz. cans
- 264- 16oz. cans
- 170 - 20oz. bottles
- 156 - 24/25oz. cans
- 200 - quarts



DRAFT

FEATURES

- One 4 keg draft refrigerator w/draft equipment
- Full panel back graphics
- Full panel, back-lit header graphics
- Header upright graphics
- 6" TPR casters

DIMENSIONS

- 84" W x 24.75" D x 87" H

CAPACITY

- Up to 4 kegs

GRAB AND GO

IRP's Grab and Go kiosk solution is the future of stadium and venue concession. Self-serve, directional vending combined with self-checkout eliminates personal interaction while providing efficient procurement of beverages for spectators.



4 WEEKS
LEAD TIME



COST EFFECTIVE
CONSTRUCTION

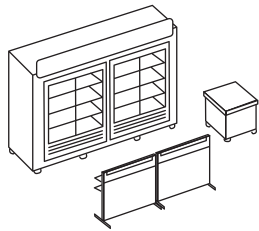

CONFIG. #1

2x 48" Crowd Corral w/rack
Double UR-2 | 32" P.O.S. Cart

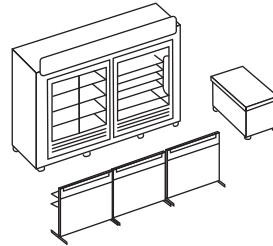

CONFIG. #2

3x 48" Crowd Corral w/rack
UR-2/Open Air | 48" P.O.S. Cart

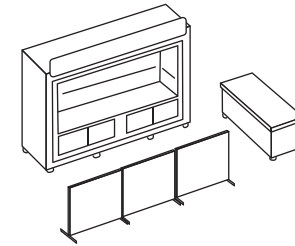

CONFIG. #3

3x 48" Crowd Corral
Merchandiser III | 72" P.O.S. Cart

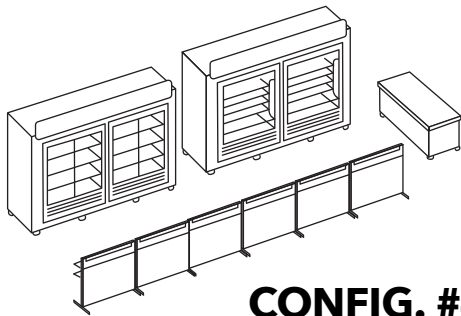

CONFIG. #4

6x 48" Crowd Corral w/rack
Double UR-2 | Double Open Air | 72" P.O.S. Cart

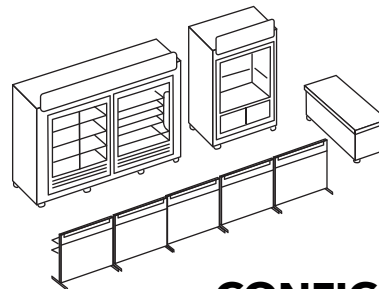

CONFIG. #5

5x 48" Crowd Corral w/rack
UR-2/Open Air | Merchandiser II | 72" P.O.S. Cart

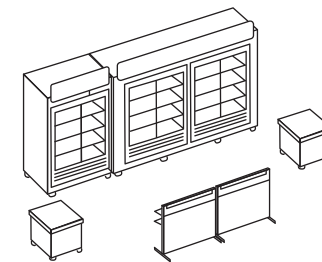

CONFIG. #6

2x 48" Crowd Corral w/rack
UR-2 | Double UR-2 | 2x 32" P.O.S. Cart

ENDLESS CONFIGURATIONS

IRP's Grab and Go can be designed in a multitude of layouts for the client depending on the space allocated, vending requirements, and quantity and size desired for the POS cart. The branded Crowd Corral is available with or without hanging racks for display of impulse snack products.



GRAB AND GO

UR-1

FEATURES

- Cyclopentane insulation
- Heavy duty wire shelves
- Electronic fan motors
- LED perimeter lighting
- Electronic thermostat
- Steel construction
- Interior lighting

DIMENSIONS

- 40.125" W x 32" D x 100.125" H

CAPACITY

- 315 - 12oz. cans
- 315 - 16oz. cans
- 240 - 20oz. bottles
- 240 - 24/25oz. cans

GRAB AND GO

UR-2

FEATURES

- Cyclopentane insulation
- Heavy duty wire shelves
- Electronic fan motors
- LED perimeter lighting
- Electronic temperature controller
- Durable steel construction

SINGLE

DIMENSIONS

- 62.125" W x 32" D x 100.125" H

CAPACITY

- 630 - 12oz. cans
- 630 - 16oz. cans
- 480 - 20oz. bottles
- 480 - 24/25oz. cans

DOUBLE

DIMENSIONS

- 118.125" W x 32" D x 100.125" H

CAPACITY

- 1,260 - 12oz. cans
- 1,260 - 16oz. cans
- 960 - 20oz. bottles
- 960 - 24/25oz. cans



GRAB AND GO

MERCHANDISER

FEATURES

- Roll up RF40 metal door
- 6” Peg hooks for hanging merchandise
- Locking lower storage area
- Heavy duty casters
- Durable steel construction
- Interior lighting

MERCHANDISER III

DIMENSIONS

- 118.125” W x 32” D x 95.625” H

CAPACITY

- 27 - 6” Peg hooks

MERCHANDISER II

DIMENSIONS

- 62.125” W x 32.125” D x 95.625” H

CAPACITY

- 18 - 6” Peg hooks

MERCHANDISER I

DIMENSIONS

- 40.125” W x 32.125” D x 95.625” H

CAPACITY

- 12 - 6” Peg hooks



GRAB AND GO

OPEN AIR

FEATURES

- OJEDA - ALPA 120
- Electronic thermostat
- Heavy duty casters
- Durable steel construction

SINGLE

DIMENSIONS

- 62.125" W x 32" D x 100.125" H

CAPACITY

- 5 Shelves
- 23 cubic feet

DOUBLE

DIMENSIONS

- 118.125" W x 32" D x 100.125" H

CAPACITY

- 10 Shelves
- 47 cubic feet

GRAB AND GO

UR-2/ OPEN AIR

DIMENSIONS

- 118.125" W x 32" D x 100.125" H

FEATURES

- OJEDA - ALPA 120
- Cyclopentane insulation
- Heavy duty wire shelves
- Electronic fan motors
- LED perimeter lighting
- Electronic Thermostat

OPEN AIR CAPACITY

- 5 Shelves
- 23 cubic feet

UR-2 CAPACITY

- 630 - 12oz. cans
- 630 - 16oz. cans
- 420 - 20oz. bottles
- 420 - 24/25oz. cans



REAR DOOR ACCESS

GRAB AND GO

PASS THRU

FEATURES

- BEV AIR PRD2-1BG
- Heavy duty casters
- Electronic temperature controller
- Durable steel construction
- Lockable rear access doors for restocking

SINGLE

DIMENSIONS

- 62.5" W x 39" D x 100.125" H

DOUBLE

DIMENSIONS

- 118.5" W x 39" D x 100.125" H

NEW



GRAB AND GO

48" CROWD CORRAL

FEATURES

- Interchangeable graphic area
- Sturdy metal frame
- Plastic LDPE feet for grip
- Choice of 2 or 3 shelf chip rack

STANDARD

DIMENSIONS

- 48" W x 16" D x 48.125" H

W/ CHIP RACK

DIMENSIONS

- 48" W x 16" D x 48.125" H

GRAB AND GO

60" CROWD CORRAL

FEATURES

- Interchangeable graphic area
- Sturdy metal frame
- Plastic LDPE feet for grip
- 4 shelf chip rack

STANDARD

DIMENSIONS

- 48" W x 16" D x 59.75" H

W/ CHIP RACK

DIMENSIONS

- 48" W x 16" D x 59.75" H



GRAB AND GO

P.O.S. CART

DIMENSIONS

- 64.25" W x 30.25" D x 78.825" H

FEATURES

- Roll up RF40 metal door
- Rear storage area
- Heavy duty casters
- Durable steel construction



32" ACM P.O.S. CART

- 34.5" W
- 33.375" D
- 36.25" H



48" ACM P.O.S. CART

- 50.5" W
- 33.375" D
- 36.25" H

GRAB AND GO

ACM P.O.S. CARTS

FEATURES

- Optional custom graphics
- Interchangeable graphic areas
- Lockable storage
- Stainless steel counter top
- Optional Point of sale access port

HAND SANITIZERS

IRP's Sanitizer Series offers three options to suite a customer's needs, functionality, and price-point. Whether the customer is looking for a budget-friendly small footprint option or the ability to dispense gallon size jugs, IRP has a solution for every business. All units in the Sanitizer Series are Made in the USA and readily available for shipment.



DURABILITY



**COST EFFECTIVE
CONSTRUCTION**



**MADE IN
THE USA**



SLIMLINE SANITIZER STAND

FEATURES

- All materials suitable for outdoor use
- ACM/SS/High Density Polyethylene Construction, will not rust or rot
- Easily assembled
- Mounting plate allows for the use of most automated dispensers
- Optional 700mL automatic dispenser

DIMENSIONS

- 17" W x 14" D x 45" H



ROTOTOUGH SANITIZER STAND

FEATURES

- Body is made with 80% recycled plastic.
- Large mounting plate allows for the use of most automated dispensers.
- Body and mounting plate are designed with ADA compliance in mind.
- Branding area on the front.
- Tilt-casters and built in handle allow easy transportation.
- Base can be filled with water or sand for added stability.

DIMENSIONS

- 15.5" W x 16.25" D x 47.5" H



FOOT PUMP HAND SANITIZER

FEATURES

- All materials suitable for outdoor use
- ACM/SS/High Density Polyethylene Construction
- Built-in anti theft using a tumbler lock
- Integrated pump stroke adjustment to control volume of sanitizer dispensed
- Adjust-ability to fit various 1gal bottles & pump styles

DIMENSIONS

- 20" W x 15" D x 42.375" H

NEW

ROTOTOUGH

RACKS

BREEZERS

FABRICATION

GRAB N GO

SANITIZERS

GRIZZLY

CUSTOM

NEW

PRECISION SERIES

ACM SINK CART

FEATURES

- 2.7 Gallon Electric Water Heater
- 5 Gallon Fresh Water Reservoir
- 8 Gallon Gray Water Reservoir
- Soap Dispenser
- 3 Gallon Trash Can
- Chrome Towel Dispenser
- Lockable Storage
- Available in Black or Brushed ACM;
Branding available on front and sides

DIMENSIONS

- 33.5"L x 33.375"D x 42.375"H



TOUCHLESS OPTION

CHROME TOWEL DISPENSER

SOAP DISPENSER



**HEATER ON/OFF
SWITCH**



ELITE SAFETY SERIES

FEATURES

- New illuminated canopy with down lighting
- Full panel Interchangeable graphics
- Steel frame for optimal strength
- 6" heavy duty casters
- Plexiglass server shield
- Mounted touchless automatic hand sanitizer

4 KEG DRAFT

DIMENSIONS

84" W x 25" D x 108" H

CAPACITY

- Up to 4 half keg barrels

PACKAGE

DIMENSIONS

62" W x 32" D x 91" H

CAPACITY

- 344 - quarts

- 612 - 12oz. cans
- 432 - 16oz. cans
- 292 - 20oz. bottles
- 280 - 24/25oz. cans



NEW

ROTOUGH

RACKS

BREEZERS

FABRICATION

GRAB N GO

SANITIZERS

GRIZZLY

CUSTOM

RECYCLING CONTAINER

NEW

FEATURES

- 2 graphic areas on each side
- Choice of circle or rectangular holes
- Rounded top prevents resting objects
- Perfect for stadiums, special events & stores
- 80% recycled material construction available

DIMENSIONS

- 21" W x 21" D x 41.239" H w/lid

CAPACITY

- 40-45 Gallon bag

ROUNDED TOP



RIBBED SIDES



WIRE BAG INSERT



STACKABLE DESIGN



DUAL RECYCLE CONTAINER NEW

FEATURES

- 2 graphic areas on each side
- Choice of circle or rectangular holes
- Rounded top prevents resting objects
- Perfect for stadiums, special events and stores
- 80% recycled material construction available

DIMENSIONS

41.930" W x 21" D x 41.239" H w/lid

CAPACITY

- 2x 40-45 Gallon bag per bin



RECYCLE BIN CAN

FEATURES

- Interchangeable graphics
- 360° graphic area
- Circular hole suited for beverage containers
- Perfect for stadiums, special events and stores

DIMENSIONS

21" Dia x 35.75" H w/lid

CAPACITY

- 60 Gallon bag



RECYCLE BIN I

FEATURES

- Stackable design
- Pyramid lid ensures containers are not placed on top of unit
- 80% recycled material construction available
- Perfect for stadiums, special events and stores

DIMENSIONS

22" W x 22" D x 39" H w/lid

CAPACITY

- 60 Gallon bag

Grizzly®

The Grizzly name stands for durability, longevity, and reliability. At Grizzly, we pride ourselves on performance and strive to create the best coolers in the market. Our rotationally molded coolers are made by the enthusiast providing optimum performance for all adventures.

We have proudly envisioned, engineered, tested, and perfected our coolers in the U.S.A., our oath to you is **FOR A LIFETIME**. We stand by our products with a Lifetime Warranty and a Bear-Proof certification from the Inter-agency Grizzly Bear Committee.



DURABILITY



MADE IN
THE USA



IN-HOUSE BRANDING
& GRAPHICS



NEW ADDITIONS TO GRIZZLY

The renowned quality and ruggedness of the Grizzly name continues to bring new products to market. The Drifter +12 now offers white and olive green color options, in addition to standard black. New product in Grizzly drinkware includes the new all metal Pint Cup and Slim Can Cooler, both available in charcoal and stainless steel. In addition, a new full body print has been made available to the Grizzly Grips and Bottles.



GRIZZLY 15

15 quart capacity

14.375" H x 18.75" L x 11.375" D



GRIZZLY 20

20 quart capacity

14.25" H x 20.25" L x 14.5" D



GRIZZLY 40

40 quart capacity

15.375" H x 25.5" L x 16" D



GRIZZLY 60

60 quart capacity

17.25" H x 30.375" L x 17.375" D

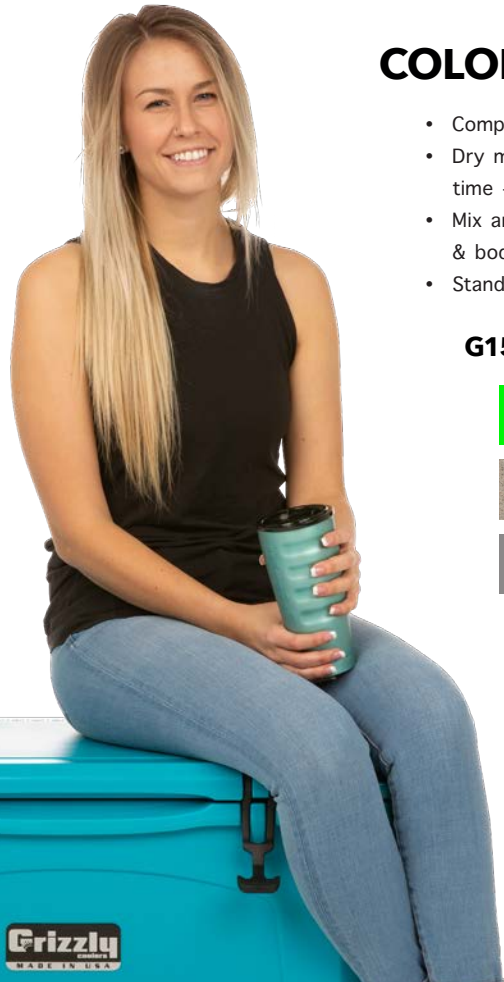

COLOR OPTIONS

- Compound color - 10,000lbs.
- Dry mix color - 3 weeks lead time + 1,000lbs. minimum
- Mix and match standard lids & bodies - 25 minimum
- Standard colors include:

G15, G20, G40, G60



ALL SIZES

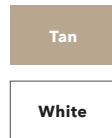

GRIZZLY 75

75 quart capacity

17.875" H x 33.125" L x 17.75" D



GRIZZLY 100

100 quart capacity

20.125" H x 37" L x 18" D



GRIZZLY 165

165 quart capacity

22.75" H x 47.75" L x 19.625" D



GRIZZLY 400

400 quart capacity

31.875" H x 54.5" L x 31" D

HARD COOLER CUSTOMIZATION

ADHESIVE



- Printed w/over-laminate adhesive
- Full color/full coverage
- Most durable type of printed graphic
- Minimum orders of one (1)
- Printed in-house up to 50 qty
- Lid & body capabilities (exclude G400)
- Spot color backgrounds using a printed color - not 100% match
- Two (2) week lead time

LID GRAPHIC

BASE GRAPHIC

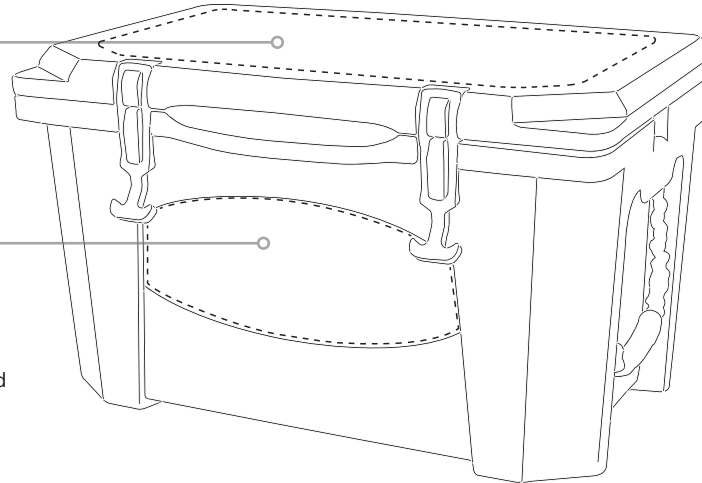

DIRECT PRINT



- Directly printed on lid
- Full color - either CMYK or spot graphics (PMS Colors)
- NOT full coverage
- No width limits, can't cover Grizzly logo
- Lid only
- UV cured ink with varnish protected
- Least durable type of printed graphic
- Minimum orders of one (1)
- Two (2) week lead time

MOLD-ON GRAPHIC



- Spot color ONLY (1-4 color logos)
- Price increases by number of colors
- Front or lid graphics available
- 10" coverage regardless of cooler size
- Durable
- Flamed on post rotomolding process - graphic becomes part of the cooler
- Minimums apply
- Longer lead times of 6-8 weeks

MOLD-IN GRAPHIC



- Spot color
- Lid only
- Durable
- Graphic done during rotomold process - graphic becomes part of the cooler
- Lead times of 6-8 weeks for graphics PLUS production lead time on coolers

DEBOSSED LID



- Lid only
- 90 day+ lead time
- Available on models: G15, G20, G40, G60, G75
- Permanent lid branding
- Set-up fee required

NEW

ROTOTOUGH

RACKS

BREEZERS

FABRICATION

GRAB N GO

SANITIZERS

GRIZZLY

CUSTOM



GRIZZLY DRIFTER 12+

FEATURES

- Waterproof ballistic polyester shell
- 100% waterproof TPU liner
- Padded shoulder strap
- Neoprene gear band
- Easy opening zippers
- Compression molded lid and base
- EVA foam insulated lid and base

DIMENSIONS

- 12" D x 13.5" H x 9" W

CAPACITY

- 12 quarts

GRIZZLY DRIFTER 20

FEATURES

- Waterproof ballistic polyester shell
- 100% waterproof TPU liner
- Padded shoulder strap
- Neoprene gear band
- Easy opening zippers
- Compression molded lid and base
- EVA foam insulated lid and base

DIMENSIONS

- 12" D 13.75" H x 15.5" W

CAPACITY

- 20 quarts

SOFT COOLER CUSTOMIZATION

HEAT TRANSFER



- CMYK - Full color
- Front – 5” Wide x 3.5” Tall
- Side Pocket – 3” Wide x 5” Tall
- Back – 5” Wide x 4.5” Tall
- 2 week lead time

SILICONE PRINT



- Spot color
- Front – 5” Wide x 3.5” Tall
- Side Pocket – 3” Wide x 5” Tall
- Back – 5” Wide x 4.5” Tall
- 2 week lead time

FULL CUSTOM



- Pantone specific color matching
- Minimum orders of 2500 for Drifter12+, 1500 for Drifter 20
- 120 days lead time till approval date

DYE SUB PRINTED



- CMYK - Full color
- Front only
- 6 week lead time

GRAPHIC AREAS

FRONT

5” Wide x 3.5” Tall

SIDE POCKET

3” Wide x 5” Tall

BACK

5” Wide x 4.5” Tall

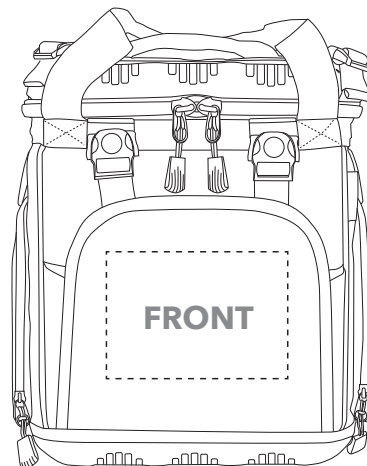



CAMP CUP

11 oz. capacity



PINT CUP

16 oz. capacity



GRIP 20oz

20 oz. capacity



GRIP 32oz

32 oz. capacity

COLOR OPTIONS

GRIP - 20oz.

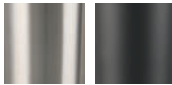

GRIP - 32oz.



CAMP CUP



BOTTLES



POUNDER, CAN, & PINT



CAN COOLER

12 oz. can capacity



SLIM CAN COOLER

12 oz. slim can capacity



POUNDER

16 oz. can capacity



BOTTLE 20oz

20 oz. capacity



BOTTLE 32oz

32 oz. capacity



BOTTLE 64oz

64 oz. capacity

DRINKWARE CUSTOMIZATION

ENGRAVING



- Single color
- Powder Coated only
- Best durability
- Minimum of 12
- No set up fee
- Done in-house

PAD PRINT



- Spot color ONLY
- 1-2 color logos done in-house
- Up to 5 colors outsourced
- Minimum of 50
- Set up fee required
- Lead time varies

DIGITAL PRINTING



- Full color
- Minimum of 24
- Set up free required
- Done in-house

FULL BODY PRINT



- Full color
- 360° print
- Minimum of 24
- Set up free required
- Only available for 20/32oz Grizzly Grips & Grizzly Bottles
- Done in-house

GRAPHIC AREAS

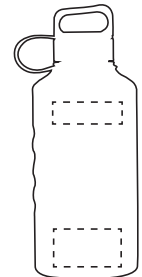
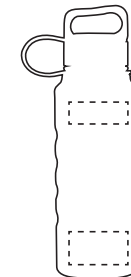
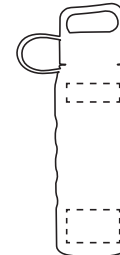
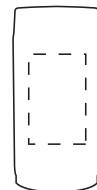
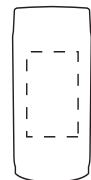
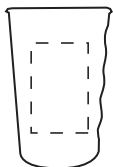
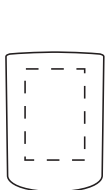

CAMP CUP

PINT CUP

CAN COOLER

SLIM CAN

POUNDER

GRIP 20oz

GRIP 32oz

BOTTLE 20oz

BOTTLE 32oz

BOTTLE 64oz

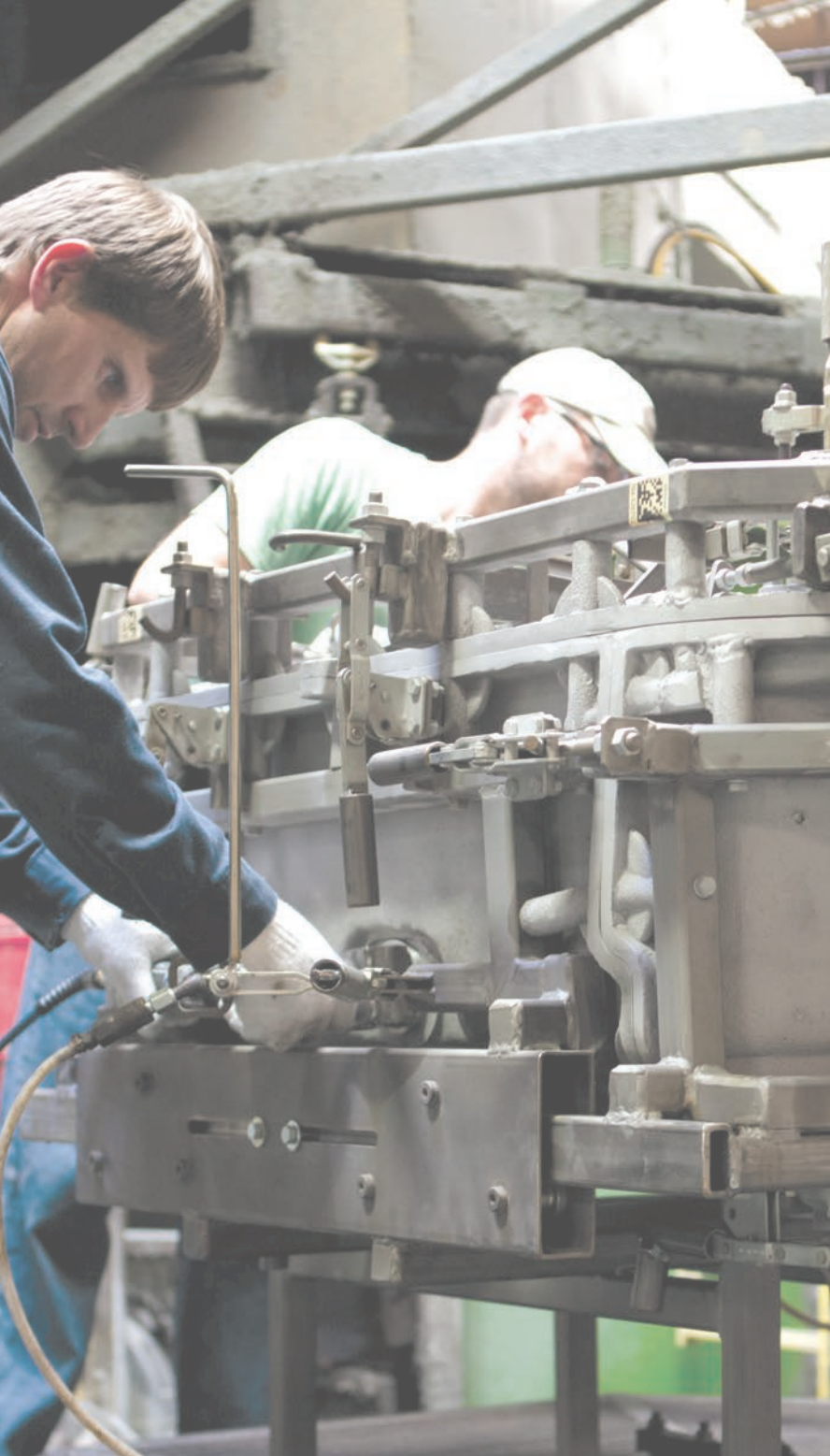

CUSTOM ROTATIONAL MOLDING

The Process Made Simple. IRP's custom rotational molding, design and product engineering teams design and manufacture rotomolded, plastic products and parts of all kinds for OEMs and other companies in every industry. With a history of skill and expertise beginning in 1983, we work with companies to develop solutions for converting products from metal, wood, fiberglass and other materials into wholly integrated, rotationally molded plastic designs. We specialize in custom rotomolding projects for commercial and industrial products.



INQUIRY



ENGINEER



QUOTE



FINALIZE



TEST



APPROVE



PRODUCE



DELIVER



NEW
ROTOTOUGH
RACKS
BREEZERS
FABRICATION
GRAB N GO
SANITIZERS
GRIZZLY

CUSTOM



CUSTOM FABRICATED KIOSKS

The Process Made Simple. IRP's custom rotational molding, design and product engineering teams design and manufacture rotomolded, plastic products and parts of all kinds for OEMs and other companies in every industry. With a history of skill and expertise beginning in 1983, we work with companies to develop solutions for converting products from metal, wood, fiberglass and other materials into wholly integrated, rotationally molded plastic designs. We specialize in custom rotomolding projects for commercial and industrial products.



INQUIRY



ENGINEER



QUOTE



REVISE



APPROVE



FABRICATE



DELIVER



INSTALL



NEW
ROTOTOUGH
RACKS
BREEZERS
FABRICATION
GRAB N GO
SANITIZERS
GRIZZLY
CUSTOM

LEADING EDGE ON-SITE PRINTING

Since 1994, our in-house printing facility, Kolor Graphics, has worked with some of the biggest names in the food and beverage industry. With our state-of-the-art printing technology, IRP can fulfill the demands of even the largest companies or brands.

Kolor Graphics can print on a variety of materials, including vinyl, styrene, adhesive, polycarbonate, and more. Carts, kiosks, racks, and merchandisers can all be customized to amplify your brand or maintain design integrity of your venue or facility.

Our team is here to make sure your order is completed to exact specifications in every step of the process.

OUR EQUIPMENT

- 1 Ink Cups 2200 PS Pad Printer
- 1 Ink Cups XJet 800
- 1 Ink Cups Heelix Digital Cup Printer
- 2 Fujifilm Acuity Advance Select HS Digital Flatbed Printers
- 2 Fujifilm Acuity X2 Digital Flatbed Printers
- 1 Epson Sure Color S40600
- 1 Epson Sure Color S80600
- 1 62" Graphtec Plotter
- 1 Ricoh Pro C5100s
- 1 Barry 54" Clamshell Die-Cutter
- 1 Seybold 100" Guillotine Sheer Cutter
- 1 Seal 62" laminator

PRINTING OPTIONS

- Signs and decals cut to shape via CNC router
- Decal work on large carts and kiosk structures, including car facade wraps
- Second surface printed polycarbonate signs and graphics
- Printed ACM signage
- Direct print and adhesive Grizzly cooler graphics, as well as spot color pad printing, full color digital printing, and laser etching on Grizzly Grips

PRINTABLE MATERIALS

- Styrene
- Vinyl
- ACM
- Polycarbonate
- Acrylic
- Adhesive
- Foam Core
- Coroplast

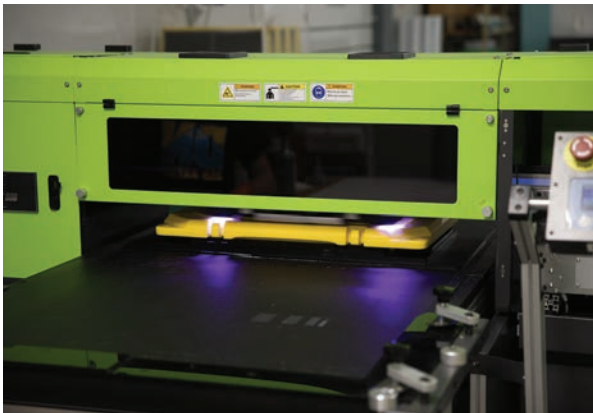

NEW

ROTOTOUGH

RACKS

BREEZERS

FABRICATION

GRAB N GO

SANITIZERS

GRIZZLY

CUSTOM



**IOWA
ROTOCAST
PLASTICS, INC.**
PLASTIC. FABRICATION. WIRE.

Check out our full line of services and more great products at

IRPINC.COM or follow us online at  **IRPINC**