

# ANHEUSER-BUSCH

## 2021 PRODUCT CATALOG

Presented By Iowa Rotocast Plastics, Inc.



[www.irpinc.com](http://www.irpinc.com)

Plastic | Fabrication | Wire

# INDEX

---

New Products | 4

RotoTough | 14

Racks & Stackers | 28

Breezers | 36

Fabrication | 38

Grab and Go | 48

Grizzly | 56

Custom | 64



Custom Capabilities page 72

# HISTORY OF IRP



- 1985** Super Cooler (the predecessor to IRP) begins production of the original keg cooler in a building constructed on the founder/CEO's home property.
- 1986** Company name changes and becomes incorporated as Iowa Rotocast Plastics, Inc. and moves to new 4,000 sq ft location in Decorah, IA.
- 1994** The Arctic is born and sold to Coca-Cola. Kolor Graphics is created as an in-house printer to fulfill the growing demands.
- 1998** IRP moves to current location in Decorah, IA and constructs 20,000 sq ft production facility.
- 2006** Several additions totaling over 100,000 additional sq ft – fabrication line developed to satisfy increasing demand for fabricated carts and kiosks. A third rotational molding oven is added to the second IRP location - a large capacity oven.
- 2009** IRP adds a 60,000 sq ft second physical location.
- 2012** Grizzly Coolers is launched as the re-branded image of roto-molded coolers manufactured by IRP taking a more B2C-focused position in the market.
- 2016** IRP adds a powder coating line to the second IRP location. A fourth rotational molding oven is added to the main IRP location - a high volume oven.
- 2017** IRP is awarded the US Bank Stadium bid in Minneapolis, MN, launching a series of stadium and venue books of business to follow.
- 2019** IRP introduces an ACM line of fabricated carts for more cost effective construction. IRP is also awarded Wrigley Field and Allianz Field stadium bids.
- 2020** In response to Covid-19, IRP developed a line of hand sanitizers to promote health and safety. Nashville Soccer and Cincinnati Soccer stadiums both award fabrication bids to IRP.
- TODAY** Launched re-branded e-commerce website and constructed new staging area in our fabrication facility. Company restructures to allow for the next generation of family members to take on executive leadership roles.



Iowa Rotocast Plastics, incorporated in 1986, is an established manufacturer and supplier of merchandising equipment for the food and beverage industry. IRP caters to beverage brands and food-service and hospitality groups, as well as working directly with stadiums, venues, and arenas to fulfill year-over-year needs.

The IRP family of brands is divided into three main product categories: RotoTough™ products that include ice-down merchandising solutions and case stackers; wire racks and electronic refrigeration; and IRP's fabricated food & beverage equipment built for on/off premise. IRP equipment meets or exceeds required industry regulations and is NSF and UL approved.

**NEW**

# BACKPACK COOLER

## FEATURES

- Lightweight design - 2.8 lbs empty
- Custom branding capability
- Water resistant integrated pocket
- Carabiner style clips
- Keeps beverages cold 24 hours

## DIMENSIONS

- 14" L x 6" W x 18 3/4" H

## CAPACITY

- 15 - 12oz cans
- 12 - 12oz slim cans
- 10 - 16oz cans
- 6 - 24/25oz cans
- 10 - 20oz bottles
- 2.8 gallons



**INTERIOR**

**TOP POCKET**

**LARGE ZIPPER HANDLE**



**BRANDING AREA**

**ADJUSTABLE STRAPS**

**CARABINER CLIPS**



# BUD LIGHT REGIONAL COOLER

## FEATURES

- Bud Light embossed lid
- Bud Light branded rubber latches
- Soft rubber handle branded Bud Light
- Machined aluminum Bud Light bottle opener

## DIMENSIONS

- Exterior: 24.5" L x 16.375" W x 17.25" H
- Interior: 19.103" L x 11.503" x 12.95" H

## CAPACITY

- 48 - 12oz cans
- 40 quartz

NEW

ROTOTOUGH

RACKS

BREEZERS

FABRICATION

GRAB N GO

GRIZZLY

CUSTOM

**NEW**

**COMING SOON**

May 2021

# ICEFALL

## FEATURES

- Removable lid with integrated vent
- Integrated reservoir tank
- Graphic slots for custom branding
- Interchangeable graphic with snap channels
- RotoTough™ Construction
- Optional chip rack

## DIMENSIONS

- 25.5" W x 16.07" D x 57.5" H

## CAPACITY

- 24 - 16oz. cans
- 24 - 20oz. bottles
- 24 - 24/25oz. cans



**WATER DRAIN**

**COMING SOON**

May 2021

# ROTO-MOLDED PUB TABLE

## FEATURES

- Cost effective Rotomolded base & top
- Table top graphics
- Optional bucket insert on table top (14.25" Dia)
- Available with branded graphics

## DIMENSIONS

- 35" Dia x 41.875" H



**BUCKET INSERT**

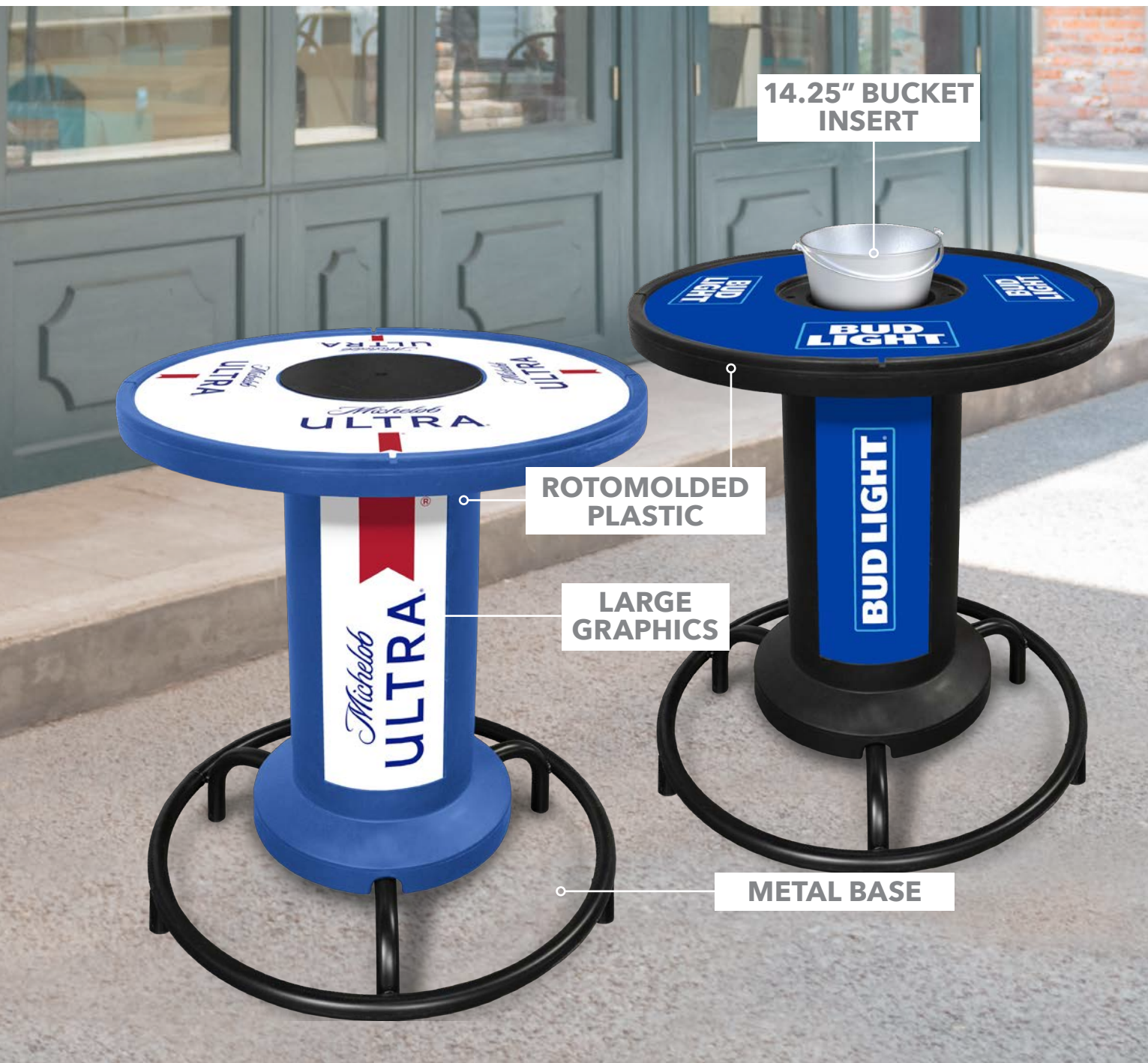

**14.25" BUCKET INSERT**

**ROTO MOLDED PLASTIC**

**LARGE GRAPHICS**

**METAL BASE**

**NEW**

**GRAB AND GO**

# CLEARVIEW

Setup your very own stop and shop store anywhere with our new portable ClearView Grab & Go! These portable units can be setup anywhere and have limitless possibilities for use. Portability, locking security doors and durable construction make the ClearView Grab & Go the perfect option for any venue.



**16' ENCLOSURE**

## 12' ENCLOSURE

### FEATURES

- Header graphic
- Direct print ACM
- Breezer UR-2 with sliding doors and custom graphics
- Compact POS marine board-24
- Black PVC header sign
- Locking tambour roll up door

### DIMENSIONS

- 161.125" W x 157.125" D x 122.562" H

## 16' ENCLOSURE

### FEATURES

- Header graphic
- Direct print ACM
- Breezer UR-2 with sliding doors and custom graphics
- Compact POS marine board-24
- Black PVC header sign
- Locking tambour roll up door

### DIMENSIONS

- 213.5" W x 157.125" D x 122.562" H

## 24' ENCLOSURE

### FEATURES

- Header graphic
- Direct print ACM
- Breezer UR-2 with sliding doors and custom graphics
- Compact POS marine board-24
- Black PVC header sign
- Locking tambour roll up door

### DIMENSIONS

- 318.25" W x 157.125" D x 122.562" H





24' ENCLOSURE

# CUSTOMIZABLE MERCHANDISING

IRP's Grab N' Go products paired with the Acrylic Enclosure allows you to create the perfect layout for your merchandising needs.



**INDOOR USE RECOMMENDED**  
OPEN AIR ROOF



12' ENCLOSURE

**NEW**

# HAND SANITIZERS

IRP's Sanitizer Series offers three options to suite a customer's needs, functionality, and price-point. Whether the customer is looking for a budget-friendly small footprint option or the ability to dispense gallon size jugs, IRP has a solution for every business. All units in the Sanitizer Series are Made in the USA and readily available for shipment.



**DURABILITY**



**COST EFFECTIVE  
CONSTRUCTION**



**MADE IN  
THE USA**



## SLIMLINE SANITIZER STAND

### FEATURES

- All materials suitable for outdoor use
- ACM/SS/High Density Polyethylene Construction, will not rust or rot
- Easily assembled
- Mounting plate allows for the use of most automated dispensers
- Optional 700mL automatic dispenser

### DIMENSIONS

- 17" W x 14" D x 45" H



## ROTOTOUGH SANITIZER STAND

### FEATURES

- Body is made with 80% recycled plastic.
- Large mounting plate allows for the use of most automated dispensers.
- Body and mounting plate are designed with ADA compliance in mind.
- Branding area on the front.
- Tilt-casters and built in handle allow easy transportation.
- Base can be filled with water or sand for added stability.

### DIMENSIONS

- 15.5" W x 16.25" D x 47.5" H



## FOOT PUMP HAND SANITIZER

### FEATURES

- All materials suitable for outdoor use
- ACM/SS/High Density Polyethylene Construction
- Built-in anti theft using a tumbler lock
- Integrated pump stroke adjustment to control volume of sanitizer dispensed
- Adjust-ability to fit various 1gal bottles & pump styles

### DIMENSIONS

- 20" W x 15" D x 42.375" H

NEW

ROTOTOUGH

RACKS

BREEZERS

FABRICATION

GRAB N GO

GRIZZLY

CUSTOM

**NEW**

**SPECIFICATIONS**

**DIMENSIONS**

- 17.18" H x 6.25" W



# WALL MOUNTED HAND SANITIZER

**FEATURES**

- Durable 3/16" wire construction
- Powder coated
- Easy installation
- Large capacity 1 gallon bottles sanitizer
- Available with or without Branding Plate

**SPECIFICATIONS**

**DIMENSIONS**

- 33.5"L x 33.375"D x 42.375"H

# ACM SINK CART

**FEATURES**

- 2.7 Gallon Electric Water Heater
- 5 Gallon Fresh Water Reservoir
- 8 Gallon Gray Water Reservoir
- Soap Dispenser
- 3 Gallon Trash Can
- Chrome Towel Dispenser
- Lockable Storage
- Available in Black or Brushed ACM;  
Branding available on front and sides
- Hands free option available



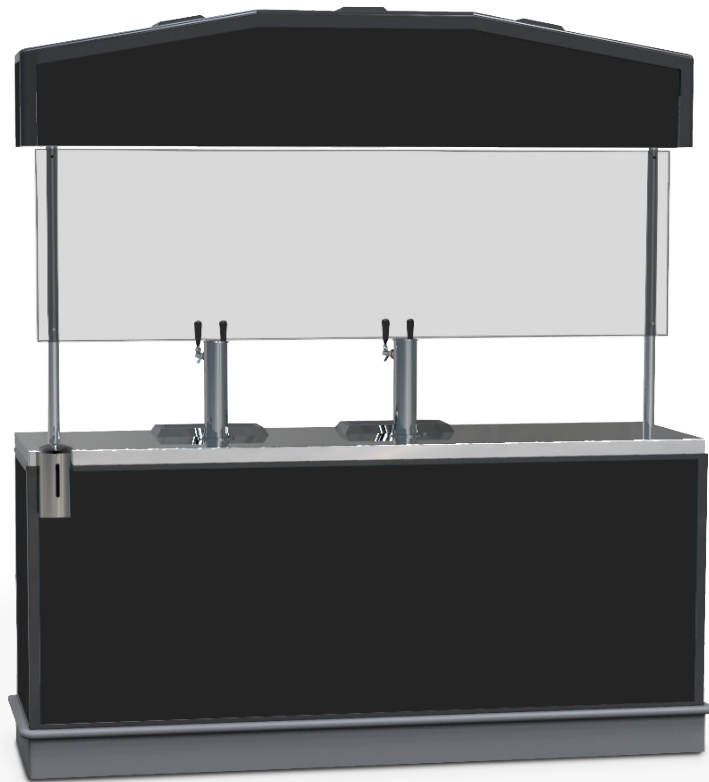

# ELITE SAFETY SERIES

## FEATURES

- New illuminated canopy with down lighting
- Full panel Interchangeable graphics
- Steel frame for optimal strength
- 6" heavy duty casters
- Plexiglass server shield
- Mounted touchless automatic hand sanitizer

**4 KEG DRAFT**

## DIMENSIONS

84" W x 25" D x 108" H

## CAPACITY

- Up to 4 half keg barrels

**PACKAGE**

## DIMENSIONS

62" W x 32" D x 91" H

## CAPACITY

- 344 - quarts

- 612 - 12oz. cans
- 432 - 16oz. cans
- 292 - 20oz. bottles
- 280 - 24/25oz. cans



**NEW**

ROTOTOUGH  
RACKS  
BREEZERS  
FABRICATION  
GRAB N GO  
GRIZZLY  
CUSTOM

# ROTOTOUGH

The IRP RotoTough product line encompasses double-walled rotationally molded plastic products with interior foam insulation. This product line is intended to chill, preserve, and promote your beverage through the use of ice. Hallmark features of this line include extreme durability and longevity...many units in the field are still in use 10-15 years after purchase. If you need a no-fuss portable workhorse with optimal ROI, the RotoTough line is the ideal choice.



DURABILITY



MADE IN THE USA



IN-HOUSE BRANDING & GRAPHICS

COUNTERTOP SERIES

# CHILLER

**FEATURES**

- Large exterior area to place graphics
- Light weight makes it easy to move to and from storage
- Small countertop footprint for virtually unlimited placement options



**SPECIFICATIONS**

**DIMENSIONS**

- 36" W x 18" D x 8" H

**CAPACITY**

- 74 - 12oz. cans
- 74 - 16oz. cans
- 60 - 20oz. bottles
- 55 - 24/25oz. cans
- 48 - quarts



COUNTERTOP SERIES

# ICER ELITE

**FEATURES**

- Great for back-bars or sampling
- Graphic channels for easy graphic swap
- 360° branding
- Lightweight, uses less plastic

**SPECIFICATIONS**

**DIMENSIONS**

- 17.25" Dia. x 9.75" H

**CAPACITY**

- 28 - 12oz. cans
- 21 - 16oz. cans
- 19 - 20oz. bottles
- 18 - 24/25oz. cans
- 22 - quarts



NEW

ROTOTOUGH

RACKS

BREEZERS

FABRICATION

GRAB N GO

GRIZZLY

CUSTOM

## SPECIFICATIONS

### DIMENSIONS

- 16.75" W x 17.5" D x 12.25" H

### CAPACITY

- 24 - 12oz. cans
- 20 - 16oz. cans
- 20 - 20oz. bottles
- 16 - 24/25oz. cans
- 24 - quarts

Black Blue Red

## SPECIFICATIONS

### DIMENSIONS

- 11" W x 11" D x 7.5" H

### CAPACITY

- 9 - 12oz. cans
- 9 - 16oz. cans
- 6 - 20oz. bottles
- 6 - 24/25oz. cans
- 6 - quarts

Black Blue Red

## COUNTERTOP SERIES

# MAXIMIZER

### FEATURES

- Large exterior area to place graphics
- Light weight makes it easy to move to and from storage
- Small countertop footprint for virtually unlimited placement options



## COUNTERTOP SERIES

# MINI-MAXIMIZER

### FEATURES

- Multiple exterior areas to place graphics
- Light weight makes it easy to move to and from storage
- Small countertop footprint for virtually unlimited placement options





# ICE CADDY 100

## FEATURES

- Interchangeable graphics
- RotoTough™ construction & handles for easy moving
- RotoTough™ removable lid for easy loading



\*Custom graphics invalidate NSF certification.



## SPECIFICATIONS

### DIMENSIONS

- 22.25" W x 30.25" D x 28.75" H

### CAPACITY

- 135 - 12oz. cans
- 100 - 16oz. cans
- 64 - 20oz. bottles
- 64 - 24/25oz. cans
- 84 - quarts
- 100 lbs. of ice



# ICE CADDY

## FEATURES

- Interchangeable graphics
- RotoTough™ construction & handles for easy moving
- RotoTough™ removable lid for easy loading

## SPECIFICATIONS

### DIMENSIONS

- 36.25" W x 27" D x 35" H

### CAPACITY

- 320 - 12oz. cans
- 240 - 16oz. cans
- 177 - 20oz. bottles
- 177 - 24/25oz. cans
- 232 - quarts





# ICE HAWK

## FEATURES

- Crystal clear lid for visibility and complete access
- Highly durable rotomolded construction with foam insulation provides superior ice retention
- Improved, easily interchangeable graphics
- Premium casters for easy mobility

## DIMENSIONS

- 21.25" Dia. x 36" H

## CAPACITY

- 106 - 12oz. cans
- 82 - 16oz. cans
- 60 - 20oz. bottles
- 52 - 24/25oz. cans
- 72 - quarts



# MERCH III

## FEATURES

- Interchangeable graphics
- Heavy duty wheel system for easy mobility
- Redesigned flat lid

## DIMENSIONS

- 16.5" Dia. x 37.25" H

## CAPACITY

- 56 - 12oz. cans
- 42 - 16oz. cans
- 30 - 20oz. bottles
- 26 - 24/25oz. cans
- 44 - quarts



# ICEBERG

## FEATURES

- Interchangeable graphics
- Unique design fits flat against aisle ends
- Heavy duty wheel system for easy mobility
- 5 quart internal reservoir

## DIMENSIONS

- 21.5" W x 16.5" D x 33.75" H

## CAPACITY

- 88 - 12oz. cans
- 66 - 16oz. cans
- 46 - 20oz. bottles
- 42 - 24/25oz. cans
- 64 - quarts

# PANTRY COOLER 2 WIDE

## FEATURES

- Interchangeable graphics
- Dividers for brand separation
- Rear wire sign holder



# PANTRY COOLER 3 WIDE

## FEATURES

- Interchangeable graphics
- Designed with convenient shelf below
- Dividers for brand separation
- Rear wire sign holder

## SPECIFICATIONS

### DIMENSIONS

- 30" W x 20" D x 51" H

### CAPACITY

- 120 - 12oz. cans
- 84 - 16oz. cans
- 55 - 20oz. bottles
- 55 - 24/25oz. cans
- 76 - quarts

## SPECIFICATIONS

### DIMENSIONS

- 36.812" W x 20.625" D x 51" H

### CAPACITY

- 108 - 12oz. cans
- 72 - 16oz. cans
- 60 - 20oz. bottles
- 60 - 24/25oz. cans
- 76 - quarts

## SPECIFICATIONS

### DIMENSIONS

- 51" W x 24" D x 38" H

### CAPACITY

- 448 - 12oz. cans
- 336 - 16oz. cans
- 196 - 20oz. bottles
- 196 - 24/25oz. cans
- 288 - quarts

Black Blue Red Forest Green

# ARCTIC

### FEATURES

- Interchangeable graphics
- Mold-in divider for easy brand separation
- Heavy duty wheels for easy mobility
- Mold-in handles and umbrella holder
- Locking lid to keep product safe



## SPECIFICATIONS

### DIMENSIONS

- 60.5" W x 31.5" D x 38" H

### CAPACITY

- 720 - 12oz. cans
- 560 - 16oz. cans
- 384 - 20oz. bottles
- 324 - 24/25oz. cans
- 440 - quarts

Black Blue Red



# SUPER ARCTIC

### FEATURES

- Interchangeable graphics
- Mold-in divider for easy brand separation
- Heavy duty wheels for easy mobility
- Mold-in handles and umbrella holder
- Optional Pole Topper w/ LED light kit
- Locking lid to keep product safe



POLE TOPPER



## TEXAS ICER

### FEATURES

- Interchangeable graphics
- Large pack-out with shelf below
- Heavy-duty drain assembly with 16 quart capacity

### DIMENSIONS

- 48" W x 24" D x 36" H

### CAPACITY

- 128 - 12oz. cans
- 105 - 20oz. bottles
- 122 - 16oz. cans
- 105 - 24/25oz. cans
- 120 - quarts

Black Blue Red

## TEXAS ICER MINI

### FEATURES

- Interchangeable graphics
- Dividers for brand separation

### DIMENSIONS

- 23.5" W x 23.5" D x 32.5" H

### CAPACITY

- 98 - 12oz. cans
- 36 - 20oz. bottles
- 63 - 16oz. cans
- 36 - 24/25oz. cans
- 64 - quarts

## TEXAS ICER JR.

### FEATURES

- Interchangeable graphics
- Designed with convenient shelf below
- Dividers for brand separation

### DIMENSIONS

- 36" W x 24" D x 34.25" H

### CAPACITY

- 96 - 12oz. cans
- 74 - 20oz. bottles
- 80 - quarts
- 74 - 16oz. cans
- 74 - 24/25oz. cans

Black Blue Red Forest Green

# AVALANCHE

## SPECIFICATIONS

### DIMENSIONS

- 30" W x 16" D x 35" H

### CAPACITY

- 160 - 12oz. cans
- 112 - 16oz. cans
- 72 - 20oz. bottles
- 72 - 24/25oz. cans
- 112 - quarts

### FEATURES

- Interchangeable graphics
- Modular design for larger pack-out with smaller footprint
- Slide-in dividers for brand separation
- Recessed graphics to keep unit looking new
- Cross-merchandising options



# AVALANCHE PLATINUM

## SPECIFICATIONS

### DIMENSIONS

- 30" W x 18" D x 32" H

### CAPACITY

- 120 - 12oz. cans
- 84 - 16oz. cans
- 60 - 20oz. bottles
- 45 - 24/25oz. cans
- 88 - quarts

### FEATURES

- Modular design for larger pack-out with smaller footprint
- Deep core with two dividers, short core kit w/dividers
- Interchangeable graphics
- Ice melt reservoir
- 2" plate caster kit





## FROST BOX

### FEATURES

- Interchangeable graphics
- Durable rotomolded construction
- Dividers to keep brands separate
- Available with skirting for a high-end look

### DIMENSIONS

- 36" W x 24" D x 34.5" H

### CAPACITY

- 144 - 12oz. cans
- 105 - 16oz. cans
- 77 - 20oz. bottles
- 77 - 24/25oz. cans
- 96 - quarts

## TEXAS TANKER

### FEATURES

- Durable Rotomolded construction
- Rotomolded divider for brand separation
- Heavy duty casters
- Interchangeable graphics

### DIMENSIONS

- 44.5" W x 27.25" D x 30.5" H

### CAPACITY

- 436 - 12oz. cans
- 296 - 16oz. cans
- 224 - 20oz. bottles
- 168 - 24/25oz. cans
- 280 - quarts



## PUSH CART

### FEATURES

- Interchangeable graphics
- Optional cash register and umbrella for all-in-one mobile selling
- Built in handles for easy mobility
- Optional pole topper with graphics and LED light kit



POLE TOPPER

### DIMENSIONS

- 53.5" W x 30" D x 40" H

### CAPACITY

- 352 - 12oz. cans
- 261 - 16oz. cans
- 141 - 20oz. bottles
- 153 - 24/25oz. cans
- 228 - quarts





## SUPER COOLER

### FEATURES

- RotoTough™ construction for extra durability
- Durable, insulated keg cooler
- Lid saves ice while allowing access to your tapper

### DIMENSIONS

- 24.5" Dia x 27" H

### CAPACITY

- 100 quarts (no keg)
- 1 keg



## ICE ISLAND

### FEATURES

- Portable reservoir tank
- Optional header card and price strips
- Optional bridge rack available
- Full panel interchangeable graphics
- Shorter core with huge pack-out saves ice and money

### DIMENSIONS

- 80" W x 35" D x 35" H

### CAPACITY

- 360 - 12oz. cans
- 216 - 16oz. cans
- 216 - 20oz. bottles
- 216 - 24/25oz. cans
- 320 - quarts



PORTABLE RESERVOIR TANK





**100% RECYCLABLE**

**IMPROVED HARNESS**

**LIGHTWEIGHT**

**LARGE GRAPHICS**

# HAWKERS

## FEATURES

- New and improved padded harness with harness attachment featuring quick detach system
- Rotomolded construction features molded-in handles with nestable design for easy storage and is 100% recyclable
- Ergonomic curved back and light weight - the lightest hawkler on the market!
- Large Recessed graphic area to amplify your brand

## MULTI HAWKER ELITE

### DIMENSIONS

- 23.125" W x 17.875" D x 7.375" H

### CAPACITY

- 32 - 12oz. cans
- 32 - 16oz. cans
- 24 - 20oz. bottles
- 24 - 24/25oz. cans

## HAWKER ELITE

### DIMENSIONS

- 22.625" W x 14.75" D x 10" H

### CAPACITY

- 64 - 12oz. cans
- 45 - 16oz. cans
- 26 - 20oz. bottles
- 25 - 24/25oz. cans



NEW  
ROTOTOUGH  
RACKS  
BREEZERS  
FABRICATION  
GRAB N GO  
GRIZZLY  
CUSTOM

# RECYCLING CONTAINER

**NEW**

## FEATURES

- 2 graphic areas on each side
- Choice of circle or rectangular holes
- Rounded top prevents resting objects
- Perfect for stadiums, special events & stores
- 80% recycled material construction available

## DIMENSIONS

- 21" W x 21" D x 41.239" H w/lid

## CAPACITY

- 40-45 Gallon bag



WIRE BAG INSERT



STACKABLE DESIGN

ROUNDED TOP



RIBBED SIDES



## DUAL RECYCLE CONTAINER NEW

### FEATURES

- 2 graphic areas on each side
- Choice of circle or rectangular holes
- Rounded top prevents resting objects
- Perfect for stadiums, special events and stores
- 80% recycled material construction available

### DIMENSIONS

41.930" W x 21" D x 41.239" H w/lid

### CAPACITY

- 2x 40-45 Gallon bag per bin



## RECYCLE BIN CAN

### FEATURES

- Interchangeable graphics
- 360° graphic area
- Circular hole suited for beverage containers
- Perfect for stadiums, special events and stores

### DIMENSIONS

21" Dia x 35.75" H w/lid

### CAPACITY

- 60 Gallon bag



## RECYCLE BIN I

### FEATURES

- Stackable design
- Pyramid lid ensures containers are not placed on top of unit
- 80% recycled material construction available
- Perfect for stadiums, special events and stores

### DIMENSIONS

22" W x 22" D x 39" H w/lid

### CAPACITY

- 60 Gallon bag



# RACKS & STACKERS

Optimized Merchandise Displays. IRP Product Displays are available in durable plastic or metal, depending on your needs and footprint. The IRP Wire Racks are an attractive solution to displaying bulk product quantities without sacrificing excessive floor space.

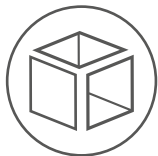

**CUSTOM  
DESIGNS**



**POWDER  
COATING**



**IN-HOUSE BRANDING  
& GRAPHICS**



**SIGNATURE SERIES**

# INTERCHANGEABLE RACK

**FEATURES**

- Interchangeable graphics
- Four shelves with shelf strip areas
- Angled shelves for ease of access

**DIMENSIONS**

- 23" W x 16.5" D x 52" H

**CAPACITY**

- 32 - 6 pack bottles
- 24 - 12 pack cans
- 12 - 18 pack cans
- 8 - 30 pack cans

**SIGNATURE SERIES**

# MINI RACK

**FEATURES**

- Interchangeable graphics
- Four shelves with shelf strip areas
- Heavy duty casters for easy mobility
- Angled shelves for ease of access

**DIMENSIONS**

- 20" W x 11" D x 62" H

**CAPACITY**

- 16 - 6 pack bottles
- 12 - 12 pack cans
- 4 - 18 pack cans
- 4 - 30 pack cans

# INTERCHANGEABLE RACK

**FEATURES**

- Interchangeable graphics
- Four shelves with shelf strip areas

**DIMENSIONS**

- 24.5" W x 17" D x 46.5" H

**CAPACITY**

- 32 - 6 pack bottles
- 24 - 12 pack cans
- 12 - 18 pack cans
- 8 - 30 pack cans



## MINI RACK

### FEATURES

- Interchangeable graphics
- Four shelves with shelf strip areas
- Sheet metal shelves available for liquor bottles

### DIMENSIONS

- 20" W x 11.5" D x 62.5" H

### CAPACITY

- 16 - 6 pack bottles
- 12 - 12 pack cans
- 4 - 18 pa cans
- 4 - 30 pack cans



### SIGNATURE SERIES

## WEEKENDER SMALL

### FEATURES

- Interchangeable graphics
- Heavy duty system for large pack-out display
- Stainless steel construction
- Four casters for easy mobility

### DIMENSIONS

- 32" W x 17" D x 61.5" H

### CAPACITY

- 24 - 12 pack cans
- 12 - 24 packs



### SIGNATURE SERIES

## WEEKENDER LARGE

### FEATURES

- Interchangeable graphics
- Heavy duty system for large pack-out display
- Stainless steel construction
- Four casters for easy mobility

### DIMENSIONS

- 32" W x 34.5" D x 61.5" H

### CAPACITY

- 72 - 12 pack cans
- 36 - 24 packs



## CASE-STACKER I

### DIMENSIONS

- 16.5" W x 11.5" D x 4.5" H

### CAPACITY

- 12oz. 12 pk glass bottles – 6 pks, 2 per layer
- 12oz. fridge pk – 8 packs, 2 per layer
- 12oz. 12 pk – 10 pks, 2 per layer
- 12oz. 24 pk – 5 pks, 1 per layer
- 12oz. 30 pk – 6 pks, 2 per layer
- 16oz. 18 pk – 5 pks, 1 per layer
- Aluminum bottles 9 pk – 6 pks, 2 per layer

## CASE-STACKER II

### DIMENSIONS

- 20.5" W x 16.5" D x 4.5" H

### CAPACITY

- 12oz. 12 pk glass bottles – 12 pks, 4 per layer
- 12oz. fridge pk – 24 pks, 4 per layer
- 12oz. 12 pk – 20 pks, 4 per layer
- 12oz. 24 pk – 10 pks, 2 per layer
- 12oz. 30 pk – 6 pks, 2 per layer
- 16oz. 18 pk – 8 pks, 2 per layer
- Aluminum bottles 9 pk – 12 pks, 4 per layer

## CASE-STACKER III

### DIMENSIONS

- 32" W x 16" D x 4.5" H

### CAPACITY

- 12oz. 12 pk glass bottles – 18 pks, 6 per layer
- 12oz. fridge pk – 30 pks, 6 per layer
- 12oz. 12 pk – 30 pks, 6 per layer
- 12oz. 24 pk – 15 pks, 3 per layer
- 12oz. 30 pk – 12 pks, 4 per layer
- 16oz. 18 pk – 16 pks, 4 per layer
- Aluminum bottles 9 pk – 24 pks, 8 per layer



## HANGING 6-PACK RACK

### FEATURES

- Use in displays or on cooler doors
- Six shelves of product display
- Adjustable width bracket

### DIMENSIONS

- 24.5" W x 7.5" D x 65.5" H

### CAPACITY

- 18 - 6 packs

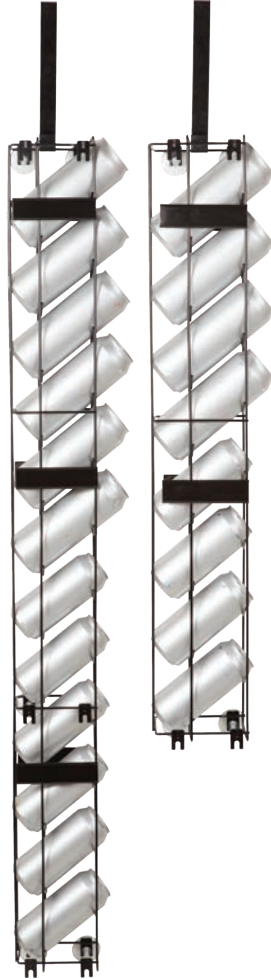

## SIDE LOADER

### FEATURES

- Multiple price strip areas
- Door hook support aided by multiple suction cups

**12 CAN**

### DIMENSIONS

- 5.5" W x 4" D x 51.5" H

### CAPACITY

- 12 - 12oz cans
- 12 - 16oz cans
- 12 - 24/25oz cans

**8 CAN**

### DIMENSIONS

- 5.5" W x 4" D x 35.5" H

### CAPACITY

- 8 - 12oz cans
- 8 - 16oz cans
- 8 - 24/25oz cans

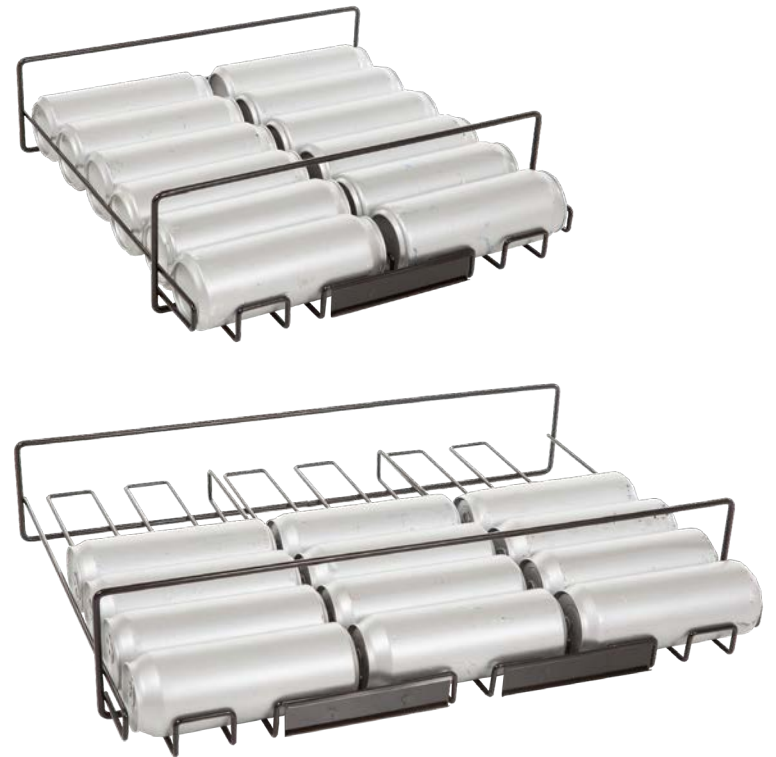

## UNDER-SHELF RACK

### FEATURES

- Price strip areas
- Sloped for products to roll toward front

**2 WIDE**

### DIMENSIONS

- 18" W x 22" D x 5" H

### CAPACITY

- 14 - 24oz cans

**3 WIDE**

### DIMENSIONS

- 25" W x 22" D x 5" H

### CAPACITY

- 21 - 24oz cans



LARGE GRAPHIC AREA

PRICE STRIP AREAS

10.5" OVERHEAD GAP

CASTERS

# 5 SHELF RACK



## FEATURES

- Interchangeable graphics
- Five shelves with price strip areas
- Product accessible from both sides
- Small Footprint – Big Pack out

## DIMENSIONS

- 16" W x 16" D x 74.5" H
- Shelf: 9.25" x 14.5"

## CAPACITY

- 75 - 12oz cans
- 75 - 16oz cans
- 30 - 4 pack slim cans
- 15 - 8 pack slim cans
- 10 - 6 pack bottles



DUAL SIDE PRODUCT ACCESS

NEW

ROTOTOUGH

RACKS

BREEZERS

FABRICATION

GRAB N GO

GRIZZLY

CUSTOM

# MINI BOTTLE RACK **NEW**

## SPECIFICATIONS

### DIMENSIONS

- 7.75" W x 6.375" D x 21" H

### CAPACITY

- 80 - 57ml bottles

### FEATURES

- Clear acrylic mini bottle display for 360 degree product viewing
- Compact size
- Clear shelf dividers
- Removable front panel for optional security



# ADJUSTABLE RACK **NEW**

## SPECIFICATIONS

### DIMENSIONS

- 18.25" W x 11.5" D x 48.375" H

### CAPACITY

- 16 - 6 pack bottles (4 per shelf)
- 12 - 12 pack cans (3 per shelf)
- 24 - 4 pack slim cans (6 per shelf)
- 72 - 20oz bottles (18 per shelf)

### FEATURES

- 4 independently adjustable shelves
- Interchangeable graphics
- Sheet metal shelves available for liquor bottles

# ROLLING RACK XL **NEW**

## FEATURES

- Interchangeable graphics
- 2 shelves for stacking product
- Steel construction
- Four casters for easy mobility

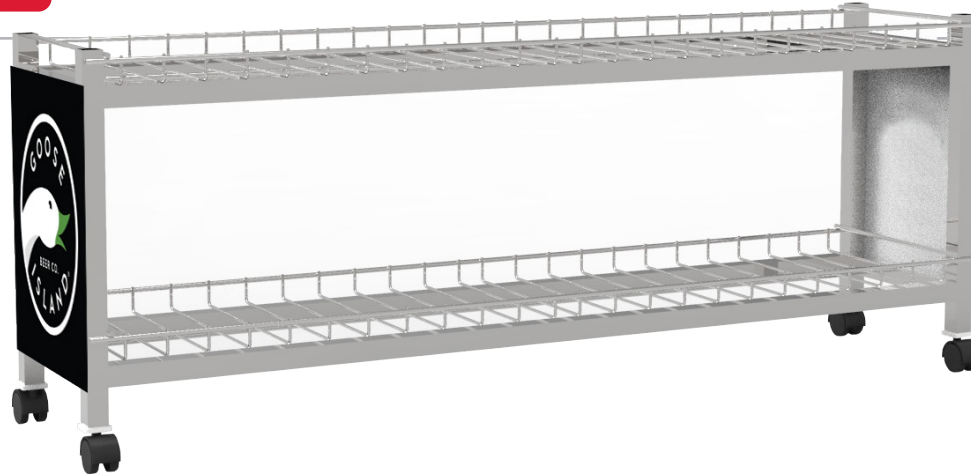

# LOW RIDER **NEW**

## FEATURES

- Interchangeable graphics
- Heavy duty casters for easy mobility
- Available with or without casters



## SPECIFICATIONS

### DIMENSIONS

- 46.625" W x 10.125" D x 20.875" H

### CAPACITY

- 36 - 12 pack cans
- 18 - 24 pack cans

## SPECIFICATIONS

### DIMENSIONS

- 46.5" W x 10.5" D x 10.5" H

### CAPACITY

- 30 - 12 pack cans
- 15 - 24 pack cans

# BREEZERS



## BREEZER CT

### FEATURES

- Durable steel construction
- Eco-friendly R134a refrigerant
- Exterior light switch and thermostat control
- LED illuminated header
- Low energy double pane tempered glass

### DIMENSIONS

- 19.125" W x 21.375" D x 36.25" H

### CAPACITY

- 84 - 12oz. cans
- 64 - 16oz. cans
- 34 - 20oz. bottles
- 64 - 24/25oz. cans

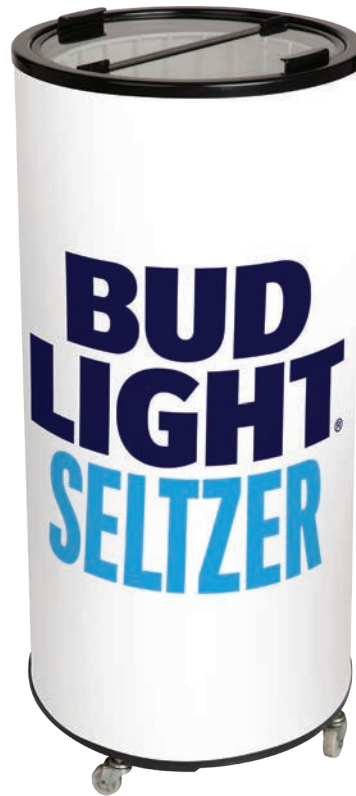

## BREEZER II

### FEATURES

- Recessed molded-in handles
- Casters for easy mobility
- Divider for brand separation
- Adjustable thermostat
- Fan assisted rapid cooling

### DIMENSIONS

- 17.5" Dai x 37.875" H

### CAPACITY

- 72 - 12oz. cans
- 62 - 16oz. cans
- 54 - 20oz. bottles
- 28 - 24/25oz. cans



## BREEZER III

### FEATURES

- Interior illumination
- Spring loaded product chutes to push product to the top
- Adjustable thermostat
- Fan assisted rapid cooling
- Minimum quantities may apply

### DIMENSIONS

- 33" W x 25.75" D x 33.5" H

### CAPACITY

- 112 - 12oz. cans
- 112 - 16oz. cans
- 112 - 24/25oz. cans



# UR BREEZERS

## FEATURES

- Casters
- Plastic front grill
- Cyclopentane insulation
- Heavy duty wire shelves
- Electronic fan motors
- LED perimeter lighting
- Locking high efficiency glass door
- Electronic temperature controller
- Durable steel construction
- Eco-friendly R134a refrigerant
- Available with sliding or hinged doors

### BREEZER UR-1

## DIMENSIONS

- 29.5" W x 27.375" D x 78.75" H

## CAPACITY

- 315 - 12oz. cans
- 315 - 16oz. cans
- 240 - 20oz. bottles
- 240 - 24/25oz. cans

### BREEZER UR-2

## DIMENSIONS

- 54.125" W x 29.625" D x 78.375" H

## CAPACITY

- 630 - 12oz. cans
- 630 - 16oz. cans
- 480 - 20oz. bottles
- 480 - 24/25oz. cans

NEW ROTOTOUGH RACKS FABRICATION GRAB N GO GRIZZLY CUSTOM

**BREEZERS**

# FABRICATED CARTS

IRP has significant experience in the design and fabrication of carts and kiosks in professional or collegiate sports venues, stadiums, arenas and resorts. IRP carts and kiosks can be created to your exact specifications, no cart is too big or small. All our carts can be designed with a combination of food & beverage serving options, or as mobile retail or P.O.S. stations.



**DURABILITY**



**MADE IN  
THE USA**



**IN-HOUSE BRANDING  
& GRAPHICS**



## IPC-280

### FEATURES

- RotoTough™ product shelf
- RotoTough™ divider for brand separation
- RotoTough™ sliding locking lid
- Available with canopy
- Interchangeable graphic system

### DIMENSIONS

- 53.5" W x 26" D x 96" H

### CAPACITY

- 448 - 12oz. cans
- 336 - 16oz. cans
- 196 - 20oz. bottles
- 196 - 24/25oz. cans
- 280 - quarts



## CYK

### FEATURES

- RotoTough™ illuminated canopy
- RotoTough™ serving shelf
- RotoTough™ divider for brand separation
- RotoTough™ handles for easy moving
- Interchangeable graphic system

### DIMENSIONS

- 60.5" W x 31" D x 96" H

### CAPACITY

- 420 - 12oz. cans
- 296 - 16oz. cans
- 204 - 20oz. bottles
- 176 - 24/25oz. cans
- 240 - quarts



## ICC-1

### FEATURES

- Industry exclusive telescoping canopy
- Product shelf with plexi front to provide theft elimination and a cleaner serving environment.
- Interchangeable graphics system
- RotoTough™ construction & heavy duty wheels
- Molded-in divider for brand separation

### DIMENSIONS

- 60" W x 30" D x 98" H

### CAPACITY

- 598 - 12oz. cans
- 428 - 16oz. cans
- 284 - 20oz. bottles
- 240 - 24/25oz. cans
- 320 - quarts

**NEW**

# MOBILE TRIKE

The newly redesigned IRP Mobile Trike offers a versatile selling platform for the vendor on the go. Available in draft or package options. This ice-down merchandiser takes to the streets.

100 QT DROP-IN  
W/ DUAL LIDS

UMBRELLA MOUNT

LARGE GRAPHICS

METAL FRAME

UMBRELLA MOUNT

LOCKING STORAGE







# MOBILE PACKAGE TRIKE NEW

## FEATURES

- Dual sided stainless steel lid
- Umbrella mount
- Locking storage underneath
- Metal bike frame

## DIMENSIONS

- 88" L x 26" W x 45.5" H

## CAPACITY

- 147 - 12 oz slim cans
- 120 - 12 oz cans
- 90 - 16 oz cans
- 70 - 24/25 oz cans
- 70 - 20 oz bottles
- 100 qt

TOP VIEW



# MOBILE DRAFT TRIKE NEW

## FEATURES

- Double spigot draft tower
- Iced-down coil bin w/lid
- 14" Drip tray
- 11 Gallon reservoir tank

## DIMENSIONS

- 88" L x 26" W x 56.5" H

## CAPACITY

- 2 - 1/6 kegs

TOP VIEW



# 3 PIECE DRAFT/ PACKAGE

If you can dream it, you can build it with the IRP Universal Ultimate Selling Station. Mix and match any option and create any size of selling station needed for your location, on or off premise.

Customizing your Universal System is a quick and easy way to get the most use from your chosen unit. Our large optional canopy provides excellent shade for vendors, as well as shelter from the elements.



## COMBINATIONS

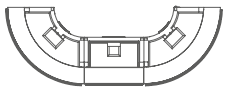

### 3 PIECE

10' 7.875" W x 3' 9.875" D x 7' 6.5" H

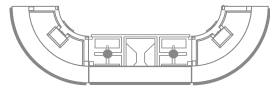

### 3 PIECE DRAFT

14' 7" W x 4' D x 7' 7" H

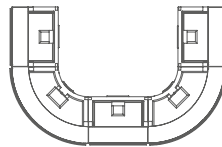

### 5 PIECE

10' 8" W x 6' 10" D x 7' 6.5" H

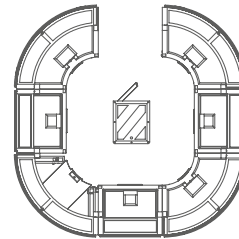

### 7 PIECE

10' 8" W x 10' 8" D x 7' 6.5" H

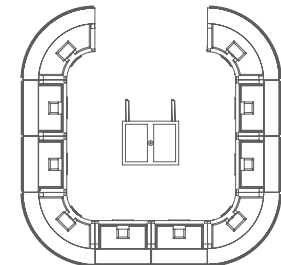

### 10 PIECE

13' 8" W x 13' 8" D x 7' 6.5" H



## CURVE

### FEATURES

- Interchangeable graphics
- RotoTough™ construction
- Optional external reservoir and locking lids

### DIMENSIONS

- 66" W x 33" D x 91" H

### CAPACITY

- 452 - 12oz. cans
- 374 - 16oz. cans
- 240 - 20oz. bottles
- 212 - 24/25oz. cans
- 280 - quarts



## STRAIGHT

### FEATURES

- Interchangeable graphics
- RotoTough™ construction
- Optional external reservoir and locking lids

### DIMENSIONS

- 36" W x 28" D x 91" H

### CAPACITY

- 336 - 12oz. cans
- 264 - 16oz. cans
- 170 - 20oz. bottles
- 156 - 24/25oz. cans
- 200 - quarts



## DRAFT

### FEATURES

- One 4 keg draft refrigerator w/draft equipment
- Full panel base graphics
- Full panel, back-lit header graphics
- Header upright graphics
- 6" TPR casters

### DIMENSIONS

- 84" W x 24.75" D x 87" H

### CAPACITY

- Up to 4 kegs



## ELITE SERIES

### FEATURES

- New illuminated canopy with down lighting
- Full panel Interchangeable graphics
- Steel frame for optimal strength
- 6" heavy duty casters
- Stainless steel uprights

### 4 KEG DRAFT

### DIMENSIONS

84" W x 25" D x 108" H

### CAPACITY

- Up to 4 half keg barrels

### PACKAGE

### DIMENSIONS

62" W x 32" D x 91" H

### CAPACITY

- 344 - quarts

- 612 - 12oz. cans
- 432 - 16oz. cans
- 292 - 20oz. bottles
- 280 - 24/25oz. cans



**PRECISION SERIES**

# ACM K89 HEADER

**FEATURES**

- Interchangeable graphics
- Down lighting
- Stainless steel counter top
- Elevated theft guard doubles as a serving shelf

**DRAFT**

**DIMENSIONS**

96"L x 32"D x 95"H

**CAPACITY**

- 380 - 12oz. cans

**PACKAGE**

**DIMENSIONS**

92"L x 32"D x 92"H

**CAPACITY**

- 456 - 12oz. cans
- 300 - 16oz. cans
- 180 - 20oz. bottles
- 180 - 24/25oz. cans
- 2 - 135 quart drop-ins

NEW  
ROTOTOUGH  
RACKS  
BREEZERS  
GRAB N GO  
GRIZZLY  
CUSTOM

**FABRICATION**



**PRECISION SERIES**

# ACM 6" BOX HEADER PACKAGE

**FEATURES**

- 32" monitor
- Interchangeable graphics
- Down lighting
- Stainless steel counter top
- Elevated theft guard
- Header custom text available

**DIMENSIONS**

92" L x 32" D x 92" H

**CAPACITY**

- 456 - 12oz. cans
- 300 - 16oz. cans
- 180 - 20oz. bottles
- 180 - 24/25oz. cans
- 2 - 135 quart drop-ins





NEW

ROTOTOUGH

RACKS

BREEZERS

**FABRICATION**

**PRECISION SERIES**

# ACM 6" BOX HEADER DRAFT

**FEATURES**

- 32" monitor
- Interchangeable graphics
- Down lighting
- Stainless steel counter top
- Elevated theft guard
- Header custom text available

**DIMENSIONS**

96" L x 25" D x 96" H

**CAPACITY**

- 4 - half keg barrels



GRAB N GO

GRIZZLY

CUSTOM



**PRECISION SERIES**

# ACM BAR CART

**DIMENSIONS**

- 74"L x 30.5"D x 45.375"H

**ELECTRIC**

**FEATURES**

- 2 - 58qt Consumable ice bins w/ SS lids; NSF Approved
- 2 - 14" Speed Rails
- 1 - 15 gallon Water Reservoir tank
- 4" Casters
- Bumper & Skirting
- Available in Black or Brushed ACM; Branding available on front and sides

**FEATURES**

- 20A P.O.S. receptacle
- Under-counter LED Lights on both customer & server side







**CHROME TOWEL DISPENSER**

**SOAP DISPENSER**

**HEATER ON/OFF SWITCH**

**PRECISION SERIES**

# ACM SINK CART

## FEATURES

- 2.7 Gallon Electric Water Heater
- 5 Gallon Fresh Water Reservoir
- 8 Gallon Gray Water Reservoir
- Soap Dispenser
- 3 Gallon Trash Can
- Chrome Towel Dispenser
- Lockable Storage
- Available in Black or Brushed ACM; Branding available on front and sides

## DIMENSIONS

- 33.5"L x 33.375"D x 42.375"H



## TOUCHLESS OPTION



## INTERIOR

NEW

ROTOTOUGH

RACKS

BREEZERS

**FABRICATION**

GRAB N GO

GRIZZLY

CUSTOM

# GRAB AND GO

IRP's Grab and Go kiosk solution is the future of stadium and venue concession. Self-serve, directional vending combined with self-checkout eliminates personal interaction while providing efficient procurement of beverages for spectators.



4 WEEKS  
LEAD TIME



COST EFFECTIVE  
CONSTRUCTION

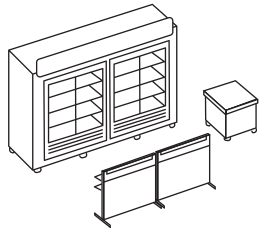

### CONFIG. #1

2x 48" Crowd Corral w/rack  
Double UR-2 | 32" P.O.S. Cart

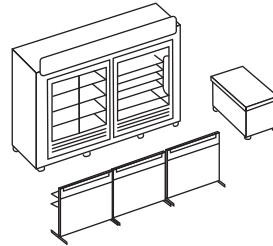

### CONFIG. #2

3x 48" Crowd Corral w/rack  
UR-2/Open Air | 48" P.O.S. Cart

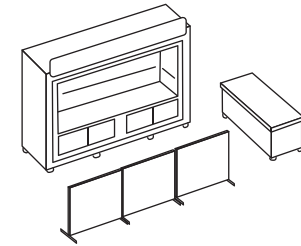

### CONFIG. #3

3x 48" Crowd Corral  
Merchandiser III | 72" P.O.S. Cart

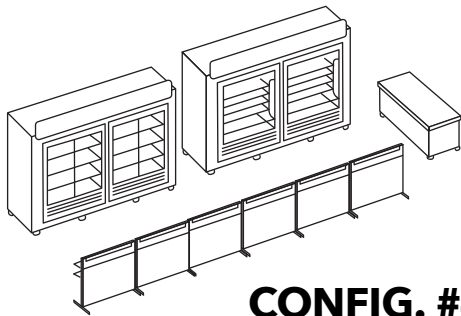

### CONFIG. #4

6x 48" Crowd Corral w/rack  
Double UR-2 | Double Open Air | 72" P.O.S. Cart

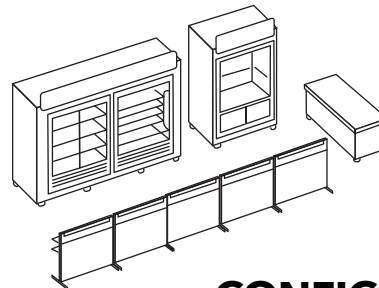

### CONFIG. #5

5x 48" Crowd Corral w/rack  
UR-2/Open Air | Merchandiser II | 72" P.O.S. Cart

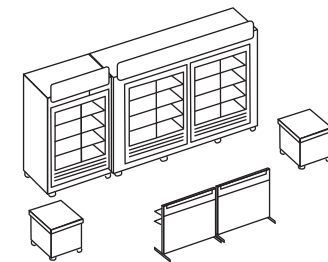

### CONFIG. #6

2x 48" Crowd Corral w/rack  
UR-2 | Double UR-2 | 2x 32" P.O.S. Cart

# ENDLESS CONFIGURATIONS

IRP's Grab and Go can be designed in a multitude of layouts for the client depending on the space allocated, vending requirements, and quantity and size desired for the POS cart. The branded Crowd Corral is available with or without hanging racks for display of impulse snack products.



**GRAB AND GO**

# UR-1

**FEATURES**

- Cyclopentane insulation
- Heavy duty wire shelves
- Electronic fan motors
- LED perimeter lighting
- Electronic thermostat
- Steel construction
- Interior lighting

**DIMENSIONS**

- 40.125" W x 32" D x 100.125" H

**CAPACITY**

- 315 - 12oz. cans
- 315 - 16oz. cans
- 240 - 20oz. bottles
- 240 - 24/25oz. cans

**GRAB AND GO**

# UR-2

**FEATURES**

- Cyclopentane insulation
- Heavy duty wire shelves
- Electronic fan motors
- LED perimeter lighting
- Electronic temperature controller
- Durable steel construction

**SINGLE**

**DIMENSIONS**

- 62.125" W x 32" D x 100.125" H

**CAPACITY**

- 630 - 12oz. cans
- 630 - 16oz. cans
- 480 - 20oz. bottles
- 480 - 24/25oz. cans

**DOUBLE**

**DIMENSIONS**

- 118.125" W x 32" D x 100.125" H

**CAPACITY**

- 1,260 - 12oz. cans
- 1,260 - 16oz. cans
- 960 - 20oz. bottles
- 960 - 24/25oz. cans



**GRAB AND GO**

# MERCHANDISER

**FEATURES**

- Roll up RF40 metal door
- 6” Peg hooks for hanging merchandise
- Locking lower storage area
- Heavy duty casters
- Durable steel construction
- Interior lighting

**MERCHANDISER III**

**DIMENSIONS**

- 118.125” W x 32” D x 95.625” H

**CAPACITY**

- 27 - 6” Peg hooks

**MERCHANDISER II**

**DIMENSIONS**

- 62.125” W x 32.125” D x 95.625” H

**CAPACITY**

- 18 - 6” Peg hooks

**MERCHANDISER I**

**DIMENSIONS**

- 40.125” W x 32.125” D x 95.625” H

**CAPACITY**

- 12 - 6” Peg hooks

NEW

ROTOTOUGH

RACKS

BREEZERS

FABRICATION

**GRAB N GO**

GRIZZLY

CUSTOM



**GRAB AND GO**

# OPEN AIR

**FEATURES**

- OJEDA - ALPA 120
- Electronic thermostat
- Heavy duty casters
- Durable steel construction

**SINGLE**

**DIMENSIONS**

- 62.125" W x 32" D x 100.125" H

**CAPACITY**

- 5 Shelves
- 23 cubic feet

**DOUBLE**

**DIMENSIONS**

- 118.125" W x 32" D x 100.125" H

**CAPACITY**

- 10 Shelves
- 47 cubic feet

**GRAB AND GO**

# UR-2/ OPEN AIR

**DIMENSIONS**

- 118.125" W x 32" D x 100.125" H

**FEATURES**

- OJEDA - ALPA 120
- Cyclopentane insulation
- Heavy duty wire shelves
- Electronic fan motors
- LED perimeter lighting
- Electronic Thermostat

**OPEN AIR CAPACITY**

- 5 Shelves
- 23 cubic feet

**UR-2 CAPACITY**

- 630 - 12oz. cans
- 630 - 16oz. cans
- 420 - 20oz. bottles
- 420 - 24/25oz. cans



REAR DOOR ACCESS

**GRAB AND GO**

# PASS THRU

**FEATURES**

- BEV AIR PRD2-1BG
- Heavy duty casters
- Electronic temperature controller
- Durable steel construction
- Lockable rear access doors for restocking

**SINGLE**

**DIMENSIONS**

- 62.5" W x 39" D x 100.125" H

**DOUBLE**

**DIMENSIONS**

- 118.5" W x 39" D x 100.125" H



**GRAB AND GO**

# 48" CROWD CORRAL

**FEATURES**

- Interchangeable graphic area
- Sturdy metal frame
- Plastic LDPE feet for grip
- Choice of 2 or 3 shelf chip rack

**STANDARD**

**DIMENSIONS**

- 48" W x 16" D x 48.125" H

**W/ CHIP RACK**

**DIMENSIONS**

- 48" W x 16" D x 48.125" H

**GRAB AND GO**

# 60" CROWD CORRAL

**FEATURES**

- Interchangeable graphic area
- Sturdy metal frame
- Plastic LDPE feet for grip
- 4 shelf chip rack

**STANDARD**

**DIMENSIONS**

- 48" W x 16" D x 59.75" H

**W/ CHIP RACK**

**DIMENSIONS**

- 48" W x 16" D x 59.75" H





**GRAB AND GO**

## P.O.S. CART

### DIMENSIONS

- 64.25" W x 30.25" D x 78.825" H

### FEATURES

- Roll up RF40 metal door
- Rear storage area
- Heavy duty casters
- Durable steel construction



## 32" ACM P.O.S. CART

- 34.5" W
- 33.375" D
- 36.25" H



## 48" ACM P.O.S. CART

- 50.5" W
- 33.375" D
- 36.25" H

**GRAB AND GO**

## ACM P.O.S. CARTS

### FEATURES

- Optional custom graphics
- Interchangeable graphic areas
- Lockable storage
- Stainless steel counter top
- Optional Point of sale access port

NEW

ROTOTOUGH

RACKS

BREEZERS

FABRICATION

**GRAB N GO**

GRIZZLY

CUSTOM

# Grizzly®

The Grizzly name stands for durability, longevity, and reliability. At Grizzly, we pride ourselves on performance and strive to create the best coolers in the market. Our rotationally molded coolers are made by the enthusiast providing optimum performance for all adventures.

We have proudly envisioned, engineered, tested, and perfected our coolers in the U.S.A., our oath to you is **FOR A LIFETIME**. We stand by our products with a Lifetime Warranty and a Bear-Proof certification from the Inter-agency Grizzly Bear Committee.



DURABILITY



MADE IN  
THE USA



IN-HOUSE BRANDING  
& GRAPHICS



# NEW ADDITIONS TO GRIZZLY

The renowned quality and ruggedness of the Grizzly name continues to bring new products to market. The Drifter +12 now offers white and olive green color options, in addition to standard black. New product in Grizzly drinkware includes the new all metal Pint Cup and Slim Can Cooler, both available in charcoal and stainless steel. In addition, a new full body print has been made available to the Grizzly Grips and Bottles.

NEW

ROTOTOUGH

RACKS

BREEZERS

FABRICATION

GRAB N GO

**GRIZZLY**

CUSTOM



### GRIZZLY 15

15 quart capacity

14.375" H x 18.75" L x 11.375" D



### GRIZZLY 20

20 quart capacity

14.25" H x 20.25" L x 14.5" D



### GRIZZLY 40

40 quart capacity

15.375" H x 25.5" L x 16" D



### GRIZZLY 60

60 quart capacity

17.25" H x 30.375" L x 17.375" D

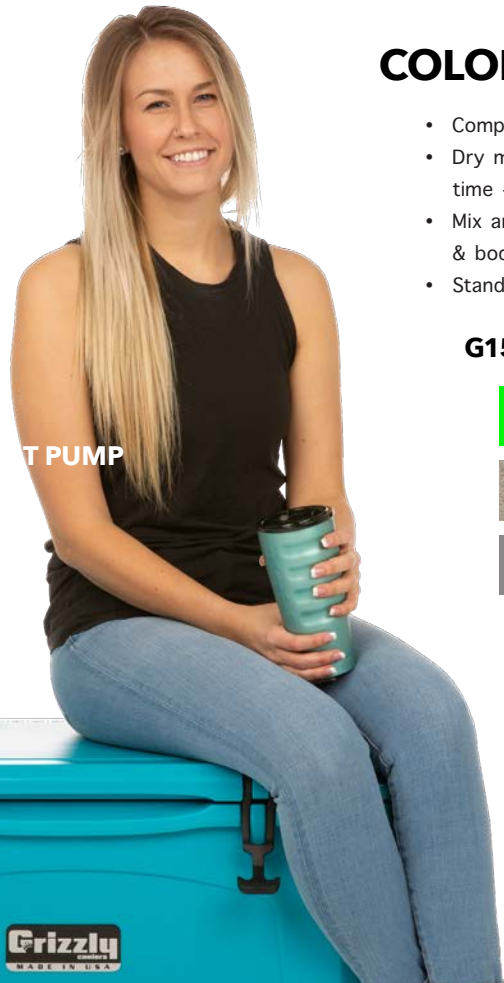

## COLOR OPTIONS

- Compound color - 10,000lbs.
- Dry mix color - 3 weeks lead time + 1,000lbs. minimum
- Mix and match standard lids & bodies - 25 minimum
- Standard colors include:

### G15, G20, G40, G60

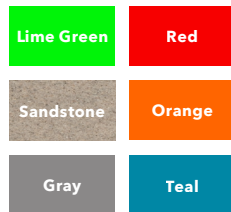

### ALL SIZES



### GRIZZLY 75

75 quart capacity

17.875" H x 33.125" L x 17.75" D



### GRIZZLY 100

100 quart capacity

20.125" H x 37" L x 18" D



### GRIZZLY 165

165 quart capacity

22.75" H x 47.75" L x 19.625" D



### GRIZZLY 400

400 quart capacity

31.875" H x 54.5" L x 31" D

# HARD COOLER CUSTOMIZATION

## ADHESIVE



- Printed w/overlaminated adhesive
- Full color/full coverage
- Most durable type of printed graphic
- Minimum orders of one (1)
- Printed in-house up to 50 qty

LID GRAPHIC

BASE GRAPHIC

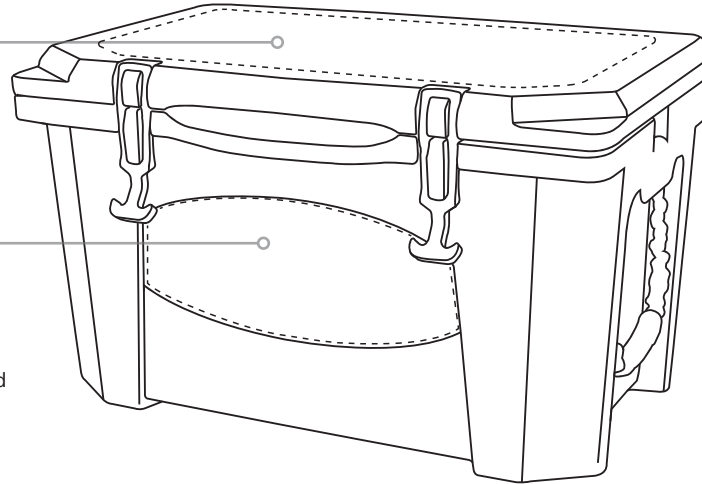

- Lid & body capabilities (exclude G400)
- Spot color backgrounds using a printed color - not 100% match
- Two (2) week lead time

## DIRECT PRINT



- Directly printed on lid
- Full color - either CMYK or spot graphics (PMS Colors)
- NOT full coverage
- No width limits, can't cover Grizzly logo
- Lid only
- UV cured ink with varnish protected
- Least durable type of printed graphic
- Minimum orders of one (1)
- Two (2) week lead time

## MOLD-ON GRAPHIC



- Spot color ONLY (1-4 color logos)
- Price increases by number of colors
- Front or lid graphics available
- 10" coverage regardless of cooler size
- Durable
- Flamed on post rotomolding process - graphic becomes part of the cooler
- Minimums apply
- Longer lead times of 6-8 weeks

## MOLD-IN GRAPHIC



- Spot color
- Lid only
- Durable
- Graphic done during rotomold process - graphic becomes part of the cooler
- Lead times of 6-8 weeks for graphics PLUS production lead time on coolers

## DEBOSSED LID



- Lid only
- 90 day+ lead time
- Available on models: G15, G20, G40, G60, G75
- Permanent lid branding
- Set-up fee required



## GRIZZLY DRIFTER 12+

### FEATURES

- Waterproof ballistic polyester shell
- 100% waterproof TPU liner
- Padded shoulder strap
- Neoprene gear band
- Easy opening zippers
- Compression molded lid and base
- EVA foam insulated lid and base

### DIMENSIONS

- 12" D x 13.5" H x 9" W

### CAPACITY

- 12 quarts

## GRIZZLY DRIFTER 20

### FEATURES

- Waterproof ballistic polyester shell
- 100% waterproof TPU liner
- Padded shoulder strap
- Neoprene gear band
- Easy opening zippers
- Compression molded lid and base
- EVA foam insulated lid and base

### DIMENSIONS

- 12" D 13.75" H x 15.5" W

### CAPACITY

- 20 quarts

# SOFT COOLER CUSTOMIZATION

## HEAT TRANSFER



- CMYK - Full color
- Front – 5” Wide x 3.5” Tall
- Side Pocket – 3” Wide x 5” Tall
- Back – 5” Wide x 4.5” Tall
- 2 week lead time

## SILICONE PRINT



- Spot color
- Front – 5” Wide x 3.5” Tall
- Side Pocket – 3” Wide x 5” Tall
- Back – 5” Wide x 4.5” Tall
- 2 week lead time

## FULL CUSTOM



- Pantone specific color matching
- Minimum orders of 2500 for Drifter12+, 1500 for Drifter 20
- 120 days lead time till approval date

## DYE SUB PRINTED



- CMYK - Full color
- Front only
- 6 week lead time

## GRAPHIC AREAS

### FRONT

5” Wide x 3.5” Tall

### SIDE POCKET

3” Wide x 5” Tall

### BACK

5” Wide x 4.5” Tall

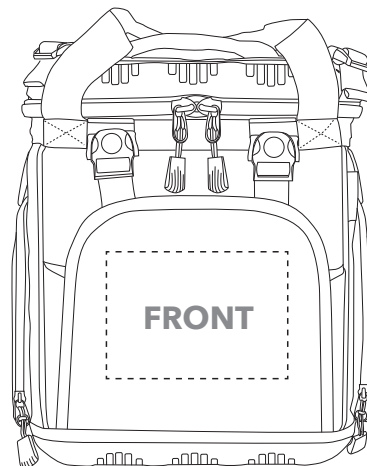



### CAMP CUP

11 oz. capacity



### PINT CUP

16 oz. capacity



### GRIP 20oz

20 oz. capacity



### GRIP 32oz

32 oz. capacity

## COLOR OPTIONS

GRIP - 20oz.

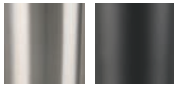

GRIP - 32oz.



CAMP CUP



BOTTLES



POUNDER, CAN, & PINT

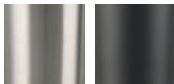

### CAN COOLER

12 oz. can capacity



### SLIM CAN COOLER

12 oz. slim can capacity



### POUNDER

16 oz. can capacity



### BOTTLE 20oz

20 oz. capacity



### BOTTLE 32oz

32 oz. capacity



### BOTTLE 64oz

64 oz. capacity



# DRINKWARE CUSTOMIZATION

## ENGRAVING



- Single color
- Powder Coated only
- Best durability
- Minimum of 12
- No set up fee
- Done in-house

## PAD PRINT



- Spot color ONLY
- 1-2 color logos done in-house
- Up to 5 colors outsourced
- Minimum of 50
- Set up fee required
- Lead time varies

## DIGITAL PRINTING



- Full color
- Minimum of 24
- Set up free required
- Done in-house

## FULL BODY PRINT



- Full color
- 360° print
- Minimum of 24
- Set up free required
- Only available for 20/32oz Grizzly Grips & Grizzly Bottles
- Done in-house

## GRAPHIC AREAS

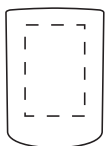

CAMP CUP

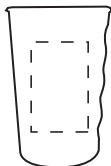

PINT CUP

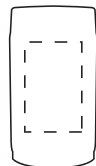

CAN COOLER

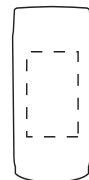

SLIM CAN

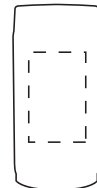

POUNDER



GRIP 20oz



GRIP 32oz

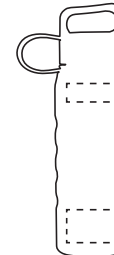

BOTTLE 20oz

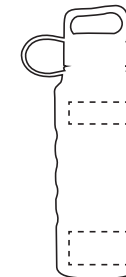

BOTTLE 32oz

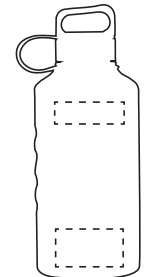

BOTTLE 64oz

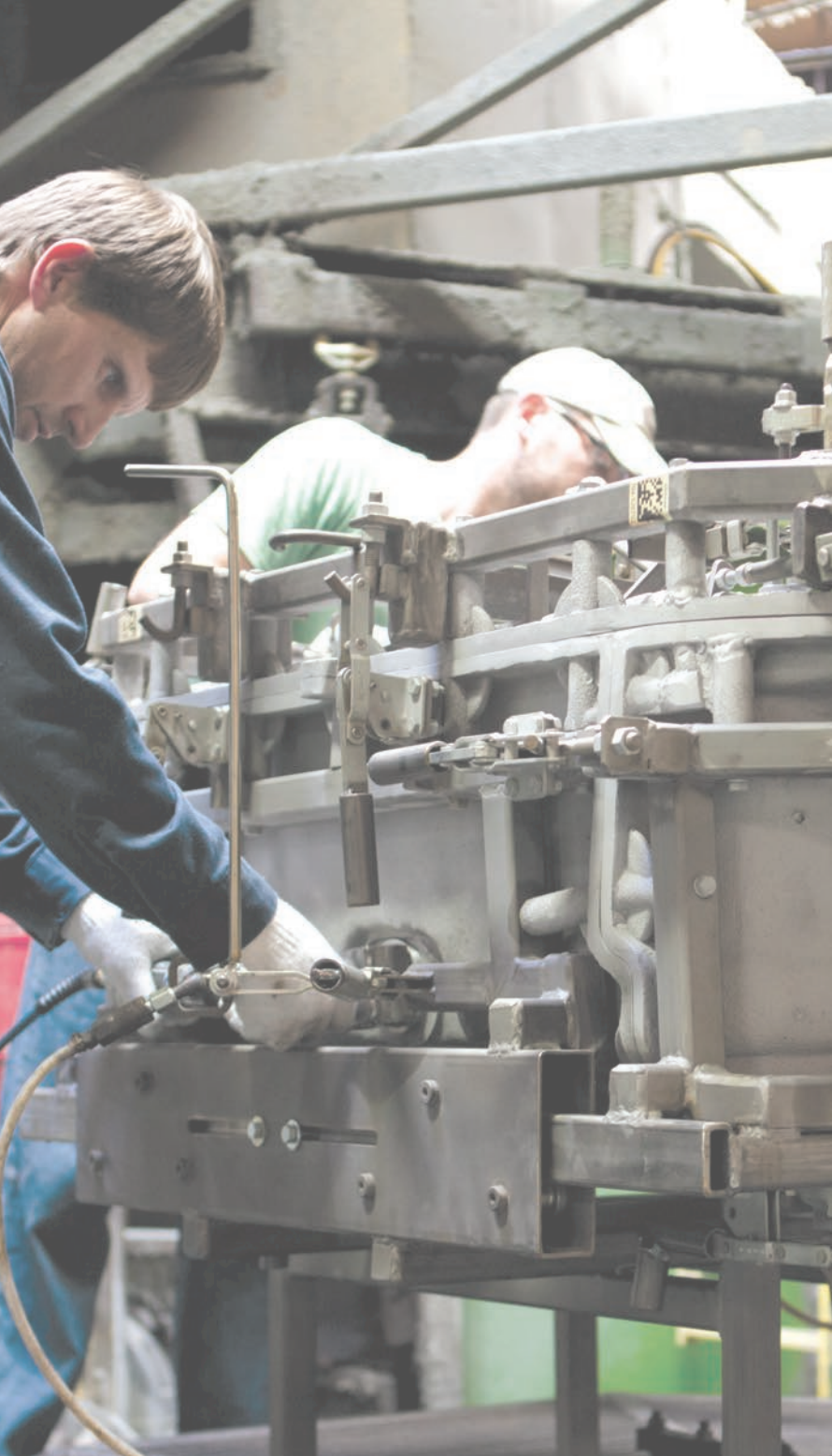

# CUSTOM ROTATIONAL MOLDING

---

The Process Made Simple. IRP's custom rotational molding, design and product engineering teams design and manufacture rotomolded, plastic products and parts of all kinds for OEMs and other companies in every industry. With a history of skill and expertise beginning in 1983, we work with companies to develop solutions for converting products from metal, wood, fiberglass and other materials into wholly integrated, rotationally molded plastic designs. We specialize in custom rotomolding projects for commercial and industrial products.



INQUIRY



ENGINEER



QUOTE



FINALIZE



TEST



APPROVE

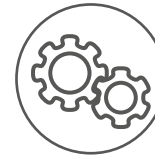

PRODUCE



DELIVER



NEW

ROTOTOUGH

RACKS

BREEZERS

FABRICATION

GRAB N GO

GRIZZLY

**CUSTOM**



# CUSTOM FABRICATED KIOSKS

---

The Process Made Simple. IRP's custom rotational molding, design and product engineering teams design and manufacture rotomolded, plastic products and parts of all kinds for OEMs and other companies in every industry. With a history of skill and expertise beginning in 1983, we work with companies to develop solutions for converting products from metal, wood, fiberglass and other materials into wholly integrated, rotationally molded plastic designs. We specialize in custom rotomolding projects for commercial and industrial products.



**INQUIRY**



**ENGINEER**



**QUOTE**



**REVISE**



**APPROVE**



**FABRICATE**



**DELIVER**



**INSTALL**



NEW

ROTOTOUGH

RACKS

BREEZERS

FABRICATION

GRAB N GO

GRIZZLY

**CUSTOM**

# LEADING EDGE ON-SITE PRINTING

---

Since 1994, our in-house printing facility, Kolor Graphics, has worked with some of the biggest names in the food and beverage industry. With our state-of-the-art printing technology, IRP can fulfill the demands of even the largest companies or brands.

Kolor Graphics can print on a variety of materials, including vinyl, styrene, adhesive, polycarbonate, and more. Carts, kiosks, racks, and merchandisers can all be customized to amplify your brand or maintain design integrity of your venue or facility.

Our team is here to make sure your order is completed to exact specifications in every step of the process.

## OUR EQUIPMENT

- 1 Ink Cups 2200 PS Pad Printer
- 1 Ink Cups XJet 800
- 1 Ink Cups Heelix Digital Cup Printer
- 2 Fujifilm Acuity Advance Select HS Digital Flatbed Printers
- 2 Fujifilm Acuity X2 Digital Flatbed Printers
- 1 Epson Sure Color S40600
- 1 Epson Sure Color S80600
- 1 62" Graphtec Plotter
- 1 Ricoh Pro C5100s
- 1 Barry 54" Clamshell Die-Cutter
- 1 Seybold 100" Guillotine Sheer Cutter
- 1 Seal 62" laminator

## PRINTING OPTIONS

- Signs and decals cut to shape via CNC router
- Decal work on large carts and kiosk structures, including car facade wraps
- Second surface printed polycarbonate signs and graphics
- Printed ACM signage
- Direct print and adhesive Grizzly cooler graphics, as well as spot color pad printing, full color digital printing, and laser etching on Grizzly Grips

## PRINTABLE MATERIALS

- Styrene
- Vinyl
- ACM
- Polycarbonate
- Acrylic
- Adhesive
- Foam Core
- Coroplast

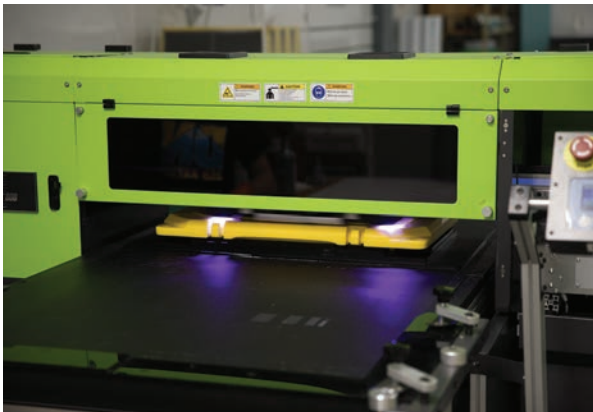

NEW

ROTOTOUGH

RACKS

BREEZERS

FABRICATION

GRAB N GO



GRIZZLY

CUSTOM



**IOWA  
ROTOCAST  
PLASTICS, INC.**  
PLASTIC. FABRICATION. WIRE.

Check out our full line of services and more great products at

**IRPINC.COM** or follow us online at    **IRPINC**