

DRINKS & MERCH

SANITIZER & SAFETY SERIES

SANITIZERS

RECYCLE BINS

FABRICATED KIOSKS

WHAT WE DO.

Iowa Rotocast Plastics, incorporated in 1986, is an established manufacturer and supplier of merchandising equipment for the grocery and c-store industry. The IRP family of brands is divided into three main product categories: RotoTough™ products that include ice-down merchandising solutions and case stackers; wire racks and electronic refrigeration. Our equipment meets or exceeds required industry regulation and is NSF and UL approved.



HAND SANITIZERS



RECYCLE BINS



FABRICATED KIOSKS

A person is standing in a modern office environment, using a floor-standing hand sanitizer dispenser. The dispenser is a tall, black, rectangular unit with a white bottle of sanitizer mounted on top. The person is wearing a dark t-shirt, blue jeans, and brown shoes. The background shows a glass door and a wooden floor. The text "HAND SANITIZERS" is overlaid on the image in white and orange.

HAND SANITIZERS



SLIMLINE SANITIZER STAND

Available with or without automatic dispenser

DIMENSIONS
45" H x 17" W x 14" D



*Touch less automatic
dispenser powered
by AA batteries.*

FEATURES

- All materials suitable for outdoor use - will not rust or rot
- ACM/SS/High Density Polyethylene Construction
- Easily assembled
- Mounting plate allows for the use of most automated dispensers
- Optional 700mL automatic dispenser

ROTOTOUGH SANITIZER STAND

 **MADE WITH 80% RECYCLED MATERIAL** 

Available with graphics and / or with sanitizer dispenser



FEATURES

- Body is made with recycled plastic.
- Large mounting plate allows for the use of most automated dispensers.
- Body and mounting plate are designed with ADA compliance in mind, allowing for dispensers to be mounted at 36 inches.
- Branding area on the front.
- Tilt-casters and built in handle allow easy transportation.

DIMENSIONS

47 1/2" H x 15 1/2" W x 16 1/4" D



Base can be filled with water or sand for added stability.

FOOT PUMP HAND SANITIZER

Available in black, white, and brushed ACM
- with or without adhesive spot graphics



White*



Brushed ACM*

DIMENSIONS

42 3/8" H x 20" W x 15" D



Sanitizer bottle pumping
system with multiple
adjustment settings

FEATURES

- All materials suitable for outdoor use - will not rust or rot
- ACM/SS/High Density Polyethylene Construction
- Built-in anti-theft using tubular lock
- Integrated pump stroke adjustment to control volume of sanitizer dispensed
- Adjustable to fit various 1gal bottles & pump styles



Black*

WALL MOUNTED HAND SANITIZER

Available with or without Branding Plate



w/ Branding Plate
17.18" H x 6.25" W



No Branding Plate
10.56" H x 6.94" W



FEATURES

- Durable 3/16" wire construction
- Powder coated
- Easy installation
- Large capacity 1 gallon bottles sanitizer

||

RECYCLE BINS



RECYCLE CONTAINER

 **MADE WITH 80% RECYCLED MATERIAL***  *80% recycled material applies to black plastic only
Custom Branding Available



Wire trash bag insert

FEATURES

- Wire insert to hold trash bag in place
- Stackable base for convenient storage
- Rounded lid to prevent beverage containers from being placed on top
- With wire insert, fits standard bag size 40 gallons and up



DIMENSIONS
41.1" H x 16.75" W x 16.75" D

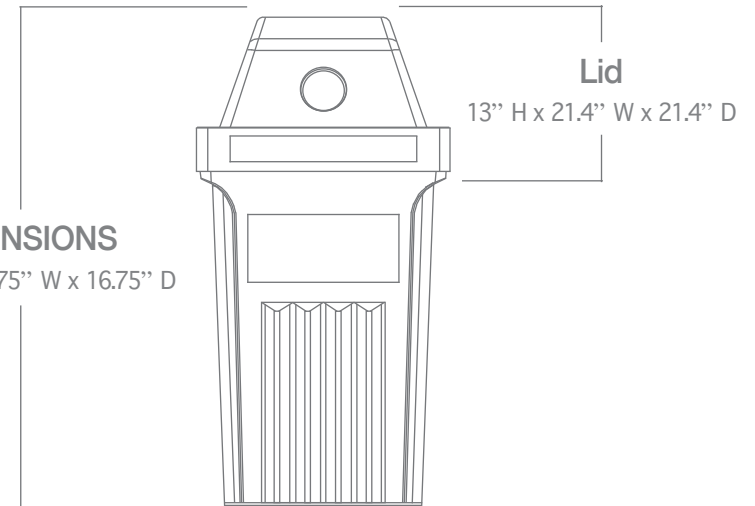

DUAL RECYCLE CONTAINER

 **MADE WITH 80% RECYCLED MATERIAL***  *80% recycled material applies to black plastic only
Custom Branding Available



-  Black
-  Sandstone
-  Red
-  Blue
-  Forest Green



Wire trash bag insert

FEATURES

- Wire insert to hold trash bag in place
- Stackable base for convenient storage
- Rounded lid to prevent beverage containers from being placed on top
- With wire insert, fits standard bag size 40 gallons and up

DIMENSIONS
40.875" H x 42.25" W
x 21.375" D

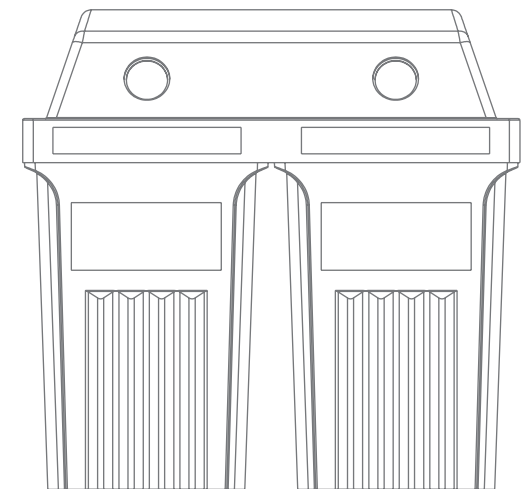



RECYCLE BIN 1

 **MADE WITH 80% RECYCLED MATERIAL***  *80% recycled material applies to black plastic only
Custom Branding Available

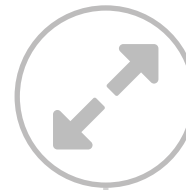

DIMENSIONS

22" W x 22" D x 39" H w/lid



FEATURES

- Optional flat lid available
- Stackable base for convenient storage
- Pyramid lid to prevent beverage containers from being placed on top
- Fits standard bag size 40 gallons and up



Black



Red



Blue



Forest Green



RECYCLE BIN CAN

Custom Branding Available

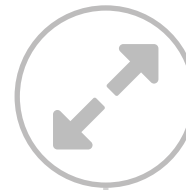

DIMENSIONS

21" D x 35.75" H w/lid



FEATURES

- 360° graphic area
- Circular hole suited for beverage containers
- Perfect for stadiums, special events and stores
- Fits standard 60 gallon bags

DRINKS & MERCH

DOM

DOM

FABRICATED KIOSKS

SOLD HERE

SOLD HERE

N-GO
ICS

GRAB-N-GO
SNACKS

DOM
DRINKS & MERCH



ACM SINK

Available in Black or Brushed ACM
- Branding available on front and sides



FEATURES

- 2.7 Gallon Electric Water Heater
- 5 Gallon Fresh Water Reservoir
- 8 Gallon Gray Water Reservoir
- Soap Dispenser
- 3 Gallon Trash Can
- 6" Rubber Skirting
- 4" Casters
- Lockable Storage

Chrome Towel
Dispenser



DIMENSIONS

42 3/8" H x 33 1/2"
W x 33 3/8" D





PACKAGE ELITE SERVER SHIELD

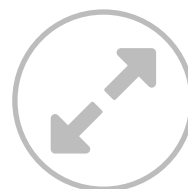

DIMENSIONS

62" W x 32" D x 91" H



FEATURES

- New illuminated canopy with down lighting
- Full panel Interchangeable graphics
- Steel frame for optimal strength
- 6" heavy duty casters
- Stainless steel uprights
- Automatic sanitizer dispenser
- Acrylic sever shield



BUILD CAPACITY

- 612 - 12oz. cans
- 432 - 16oz. cans
- 292 - 20oz. bottles
- 280 - 24/25oz. cans
- 344 - quarts



DRAFT ELITE SERVER SHIELD

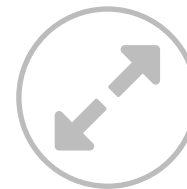

DIMENSIONS

84" W x 25" D x 108" H



FEATURES

- New illuminated canopy with down lighting
- Full panel interchangeable graphics
- Steel frame for optimal strength
- 6" heavy duty casters
- Stainless steel uprights
- Automatic sanitizer dispenser
- Acrylic server shield



BUILD CAPACITY

- Up to 4 half kegs

12' CLEARVIEW GRAB & GO



DIMENSIONS

161.125" W x 157.125" D x 122.562" H



FEATURES

- Portable
- Materials: Aluminum & Acrylic Panels
- Locking Roll Up Doors for Security
- Interior LED Lighting
- 4 Direct Print ACM Graphic Panels
- PVC Signage with Uplighting
- GFCI Outlets
- POS Receptacle



BUILD CAPACITY

- Encloses 144 sq-ft

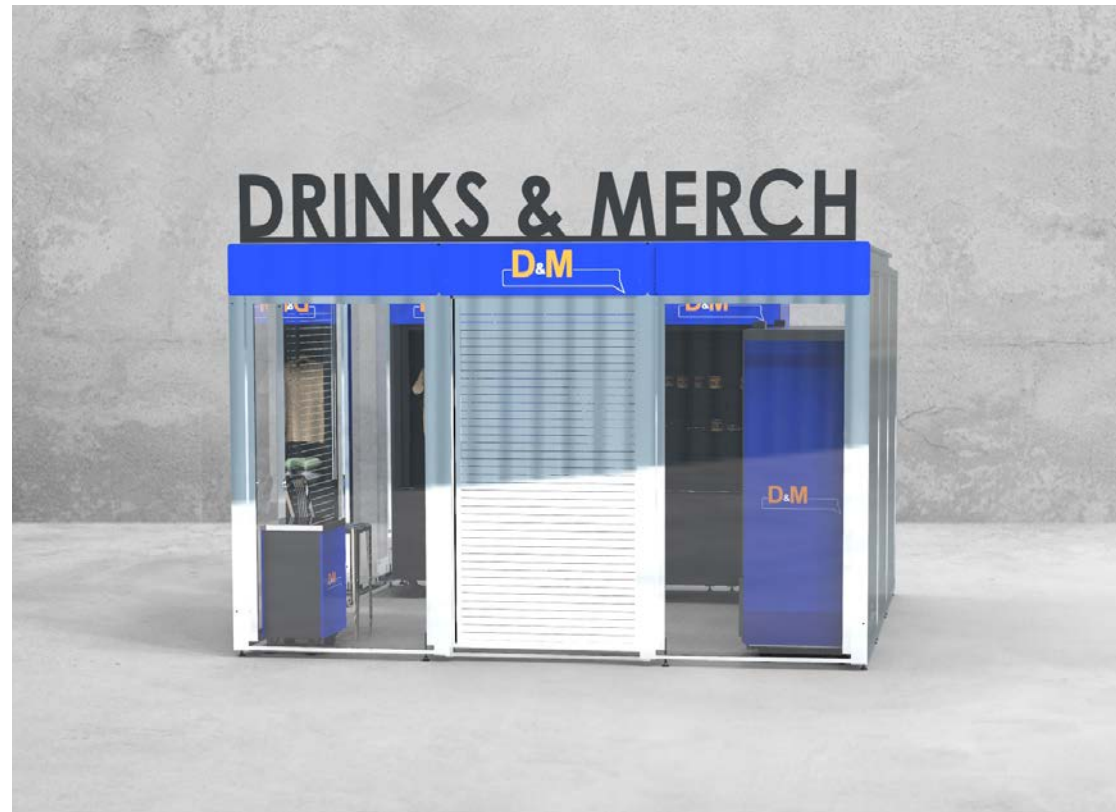

DRINKS & MERCH



Price as shown: \$31,994

Includes: 12' ClearView Grab and Go

2 - Double Door Breezers w/ Graphics

1 - Large Merchandiser III Cart

1 - 24" POS Cart

2 - Locking Security Doors

LED Lighting

Branding of your choice

All information herein is confidential and proprietary and is owned solely by Iowa Rotocast Plastics, Incorporated. All rights reserved.

16' CLEARVIEW GRAB & GO



DIMENSIONS

213.5" W x 157.125" D x 122.562" H



FEATURES

- Portable
- Materials: Aluminum & Acrylic Panels
- Locking Roll Up Doors for Security
- Interior LED Lighting
- 4 Direct Print ACM Graphic Panels
- PVC Signage with Uplighting
- GFCI Outlets
- POS Receptacle



BUILD CAPACITY

- Encloses 192 sq-ft



DRINKS & MERCH



Price as shown: \$33,245

Includes: 16' ClearView Grab and Go

5 - Double Door Breezers w/ Graphics

1 - 24" POS Cart

2 - Locking Security Doors

LED Lighting

Branding of your choice

All information herein is confidential and proprietary and is owned solely by Iowa Rotocast Plastics, Incorporated. All rights reserved.

24' CLEARVIEW GRAB & GO



DIMENSIONS

318.25" W x 157.125" D x 122.562" H



FEATURES

- Portable
- Materials: Aluminum & Acrylic Panels
- Locking Roll Up Doors for Security
- Interior LED Lighting
- 4 Direct Print ACM Graphic Panels
- PVC Signage with Uplighting
- GFCI Outlets
- POS Receptacle



BUILD CAPACITY

- Encloses 300 sq-ft



DRINKS & MERCHANDISE



Price as shown: \$44,889

Includes: 24' ClearView Grab and Go

- 4 - Double Door Breezers w/ Graphics
- 1 - Large Merchandiser III Cart
- 1 - 32" POS Cart
- 2 - Locking Security Doors
- LED Lighting
- Branding of your choice



**IOWA
ROTOCAST
PLASTICS, INC.**
PLASTIC. FABRICATION. WIRE.

Check out our full line of services and more great products at
IRPINC.COM or follow us online at [@IRPINC](#)